



CHAPTER III

EXPERIMENTAL

3.1 Chemicals

The high ammonia natural rubber (NR) latex containing ca. 60% DRC was obtained from Thai rubber latex Corporation Public Co., Ltd. (Bangkok, Thailand). The NR latex has the properties as described in Appendix A. The commercial grade nitrogen gas (N₂) with 95% purity was supplied by Thai Industrial Gas, (Samutprakarn, Thailand). Potassium hydroxide (KOH) was obtained from Ajax Finechem (Seven Hills, Australia). Sodium dodecylsulfate (SDS) and isopropanol were obtained from Fisher Scientific (Loughborough, UK). Methyl methacrylate (MMA) monomer was purchased from MERCK (Hohenbrunn, Germany). 80% cumene hydroperoxide (CHPO) solution and tetraethylene pentamine (TEPA) were obtained from ACROS ORGANICS (New Jersey, USA). Anhydrous sodium sulfate (Na₂SO₄) was obtained from Fisher Scientific (Loughborough, UK). Petroleum ether (PE) was obtained from Mallinckrodt Chemicals (New Jersey, USA) and acetone was recieved from QReC™ (New Zealand).

3.2 The design and construction of the microwave system

The microwave system for the graft copolymerization was designed as shown in Figure 3.1. The microwave system consists of magnetron power supply, microwave generator (magnetron head), waveguide, microwave chamber, glass reactor, temperature control and cooling system.

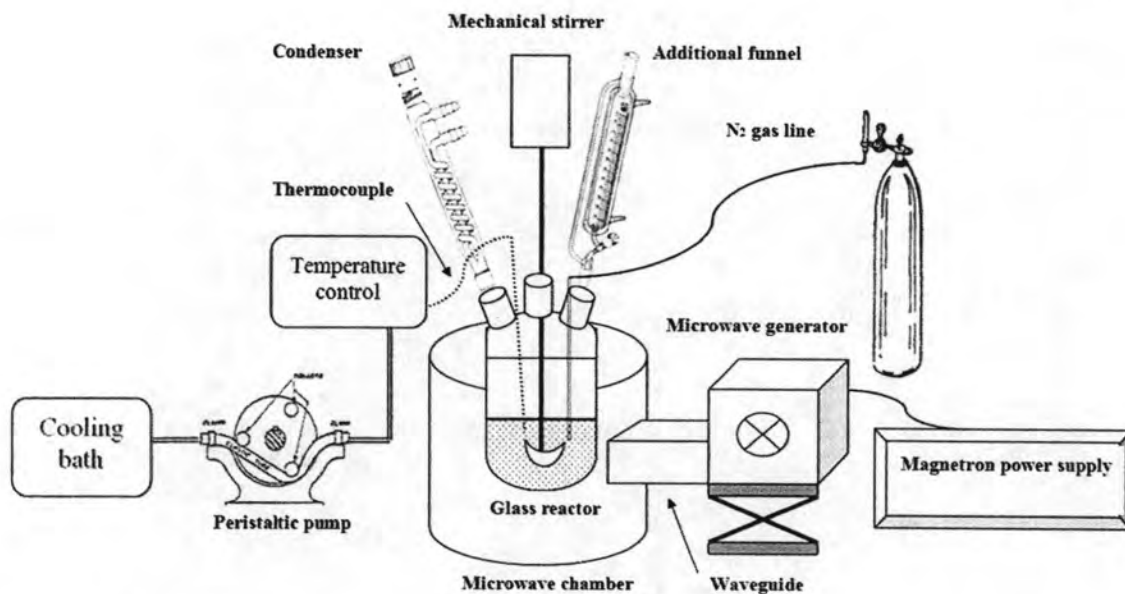

Figure 3.1 The drawing apparatus of the microwave system for the graft copolymerization.

3.2.1 Glass reactor

The 800 mL of five-necked glass reactor was made from borosilicate glass. It was equipped with mechanical stirrer, condenser, N₂ gas line, thermocouple and additional funnel with PTFE needle valve (Figure 3.1). The peristaltic pump was also connected to cooling tube of glass reactor. The design of glass reactor is shown in Figure B-1 in Appendix B.

3.2.2 Microwave chamber

The microwave chamber with a $\pi \times 15^2 \times 30$ cm³ cylindrical cavity ($\pi r^2 h$) was made from stainless steel with 36 cm of outer diameter, 30 cm of inner diameter and 30 cm of height (Figure 3.3). The glass reactor must be placed in the microwave chamber to allow microwave transmission into the reaction mixture.

3.2.3 Rectangular waveguide and mode excitation design

Microwave is an electromagnetic wave with wavelengths in the range of 1 cm to 1 m or corresponding frequency in the range 300 MHz to 30 GHz.

Traditional microwave research mostly utilize at 2,450 MHz (2.45 GHz) which is the same frequency as domestic microwave oven. The dimensions of waveguide are depended on the specific frequency range of which its electromagnetic wave can propagate and relate to the cut-off frequency ($f_{c_{mn}}$). The lowest frequency of an electromagnetic wave that can propagate is called cut-off frequency. In a rectangular waveguide, the propagation waves can be in both the TE_{mn} modes (transverse electric, no electric field component in the direction of propagation) and the TM_{mn} modes (transverse magnetic, no magnetic field in the direction of propagation) where m and n are the integers followed from Helmholtz equation (Collin, 1992).

An air-filled stainless steel rectangular waveguide based on the WR340 standard ($86.4 \times 43.2 \text{ mm}^2$) has been designed. Due to this dimensions, only the TE_{10} mode can propagate the electric and magnetic field lines as shown in Figure 3.2. The dimension is related to the cut-off frequency as shown in Eq. 3.1.

$$f_{c_{mn}} = \frac{c}{2\pi} \sqrt{\left(\frac{m\pi}{a}\right)^2 + \left(\frac{n\pi}{b}\right)^2} \quad (3.1)$$

where a = width of the waveguide (86.4 mm)

b = height of the waveguide (43.2 mm)

c = velocity of light

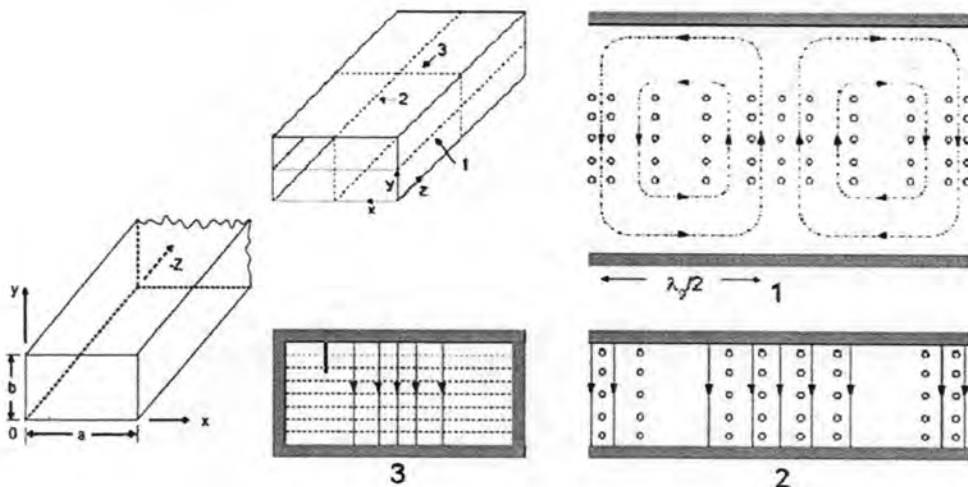

Figure 3.2 Electric and magnetic field lines for TE_{10} mode in rectangular waveguide (Pozar, 1998).

For the WR340, the cut-off frequency is 1.72 GHz (inside width (a) = 86.4 mm, and inside height (b) = 43.2 mm) which is less than 2.45 GHz. Therefore, the electromagnetic wave can propagate. Furthermore, the wavelength within the waveguide (λ_g) also relates to the free space wavelength ($\lambda_0 = 121.6$ mm), by the relation (Eq. 3.2) (Španěl et al., 2004).

$$\lambda_g = \frac{\lambda_0}{\sqrt{1 - (f_c/f)^2}} \quad (3.2)$$

For f_c of 1.72 GHz and f of 2.45 GHz, the value of λ_g is 170 mm. Therefore, the rectangular waveguide in this research is designed with the length of 212 mm to get the $2\lambda_g$ (2 loops = 340 mm) as shown in Figure 3.3. The magnetron head is coupled via this waveguide at distance of 22 mm from the end cap (see Figure 3.3), which is used as a standard coupling (Španěl et al., 2004). In order to excite the strong electric field of TE₁₀ mode in rectangular waveguide, an antenna of magnetron head is placed vertically at $x = a/2$ (a is a 86.4 mm).

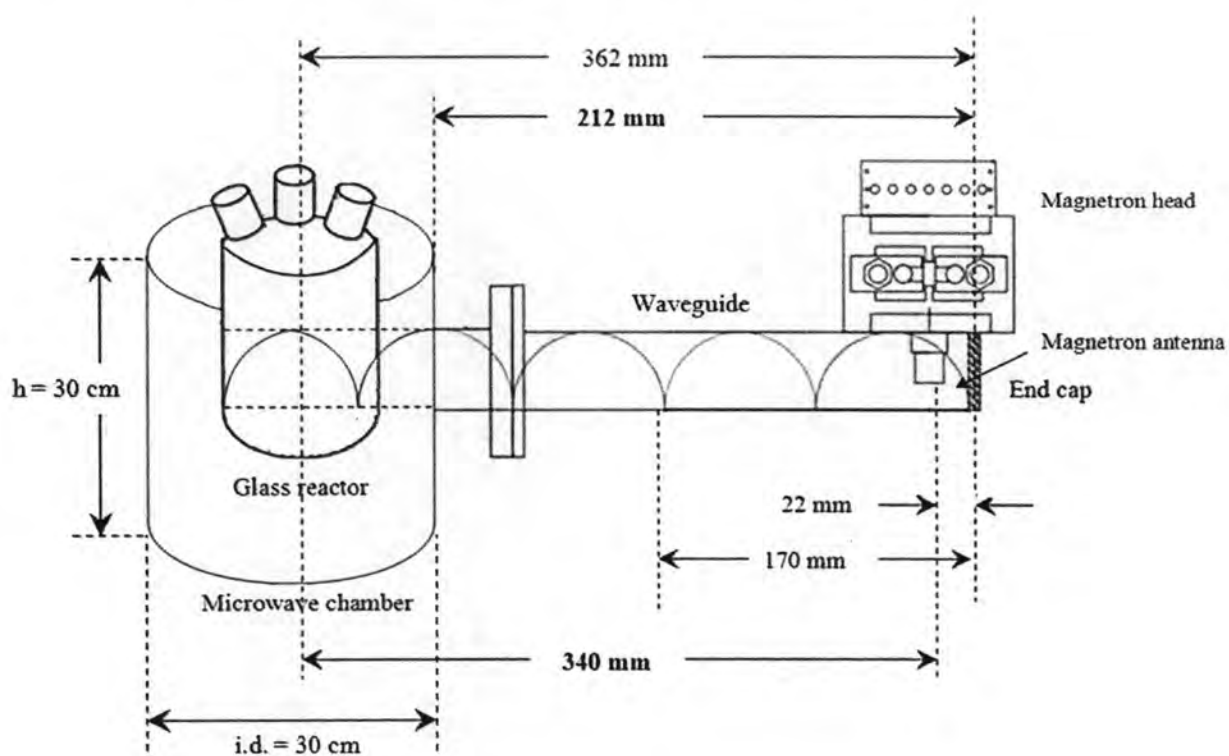

Figure 3.3 Schematic diagram of the length of rectangular waveguide in this research.

3.2.4 Magnetron power supply

The circuit diagram consists of two main parts which are low and high voltage circuits as shown in Figure 3.4a. For the low voltage circuit, an applied voltage as ca. 3-4 V with 10 A of electrical current would produce electrons around the cathode. The high voltage provides potential difference between the anode and the cathode of ca. 3000 V. This causes the electrons to blast off from the cathode and accelerate straight towards the anode. The potential difference between the anode and the cathode is adequate to generate a radiation of electromagnetic waves as the output of the magnetron head. The power supply of this magnetron can be adjusted to the power in the range of 0-500 watt.

In this research, the microwave power source (magnetron head) is supplied by Amorn Electronics Center (Bangkok, Thailand). The photograph of 2M 218J magnetron head is shown in Figure 3.4b.

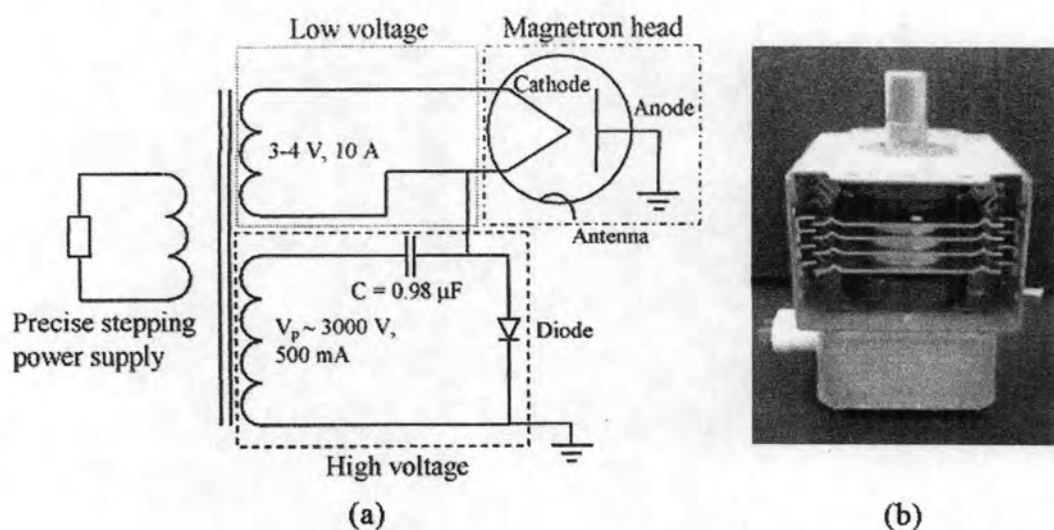

Figure 3.4 Scheme of (a) circuit diagram of the voltage supplied to the magnetron head. (b) the 2M 218J magnetron head utilized in this research.

3.3 Experimental procedure

3.3.1 Measurement of dielectric properties of substances

The dielectric properties of substances for graft copolymerization were measured at 25°C using a portable dielectric measurement (Network Analyzer) over a frequency band ranging from 1.6 to 2.6 GHz as shown in Figure 3.5. The portable dielectric measurement kit is used for measurement of the complex permittivity (related to the dielectric constant, ϵ'_r and loss factor, ϵ''_r) over a wide range of solid, semi-solid, granular and liquid materials. It performs all of the necessary control functions, treatment of the microwave signals, calculation, data processing, and results representation. The software controls the microwave reflectometer to measure the complex reflection coefficient of the material under test (MUT). It detects the cavity resonant frequency and quality factor and converts the information into the complex permittivity of the MUT. Finally, the measured results are displayed in a variety of graphical formats, or saved to disk (Somsak Vongpradubchai and Phadungsak Rattanadecho, 2009).

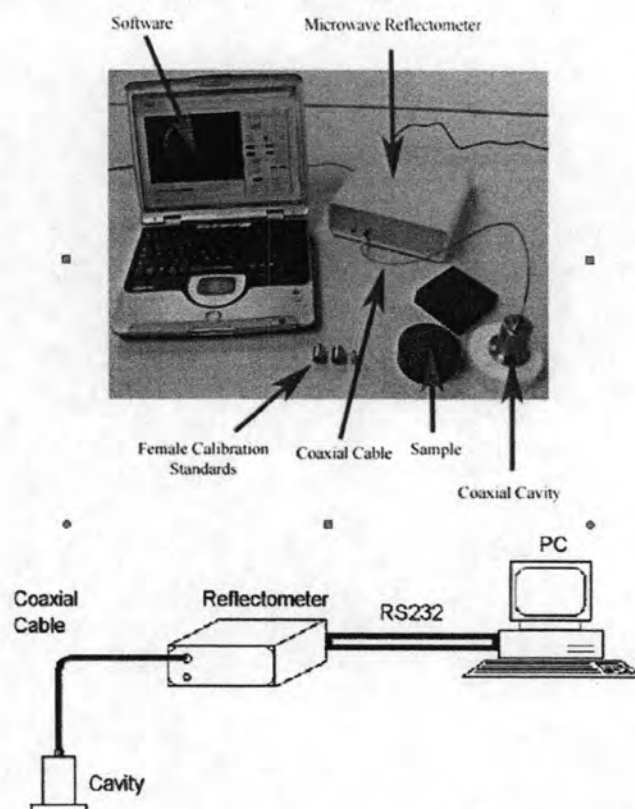

Figure 3.5 Portable dielectric measurement (Network Analyzer; PUSCHNER, GERNAMY) (Makul et al., 2009).

3.3.2 Purification of monomers

The purification method for methyl methacrylate (MMA) was described in the previous literature (Wanvimon Arayapranee et al., 2002). The MMA monomer (b.p. 100 °C/760 mmHg) contained a trace amount of hydroquinone used as an inhibitor for self-polymerization of MMA. The inhibitor was removed by washing with 5% of NaOH solution. The MMA monomer was washed with deionized water until neutral, and then dried with anhydrous Na₂SO₄. The dried MMA monomer was distilled under reduced pressure (50-60 °C/200 mmHg). Finally, the obtained pure MMA monomer was stored in a refrigerator.

3.3.3 Preparation of graft natural rubber (GNR)

The conventional and microwave apparatuses for graft copolymerization experiment used in this research are shown in Figure 3.6a and 3.6b, respectively. The recipe for preparation of GNR induced by microwave is shown in Table 3.1. The 50 g of NR latex and deionized water were charged into the reactor. KOH (1 phr) used as a buffer and SDS (1 phr) used as an emulsifier were then added under constant stirring rate. The mixture was deoxygenated by bubbling the nitrogen gas at room temperature. Isopropanol (10 phr) used as a stabilizer was added. MMA (50 phr) was gradually dropped into the reaction mixture and allowed to swell the latex particles. The mixture was heated up by using 100 W of microwave power. When the temperature was risen to 60°C, the power of microwave was turned off. The CHPO and TEPA used as redox initiators were then dropped into the reaction mixture. The microwave power was started again and adjusted to the desired microwave power. When the reaction was ceased after 20 min, the obtained graft product was isolated in 95% purity ethanol and dried at 50°C for 48 h. The grafting properties of graft product were determined by soxhlet extraction (Wanvimon Arayapranee et al., 2002). The overall experimental scopes of this research is presented in Figure 3.7.

(a)

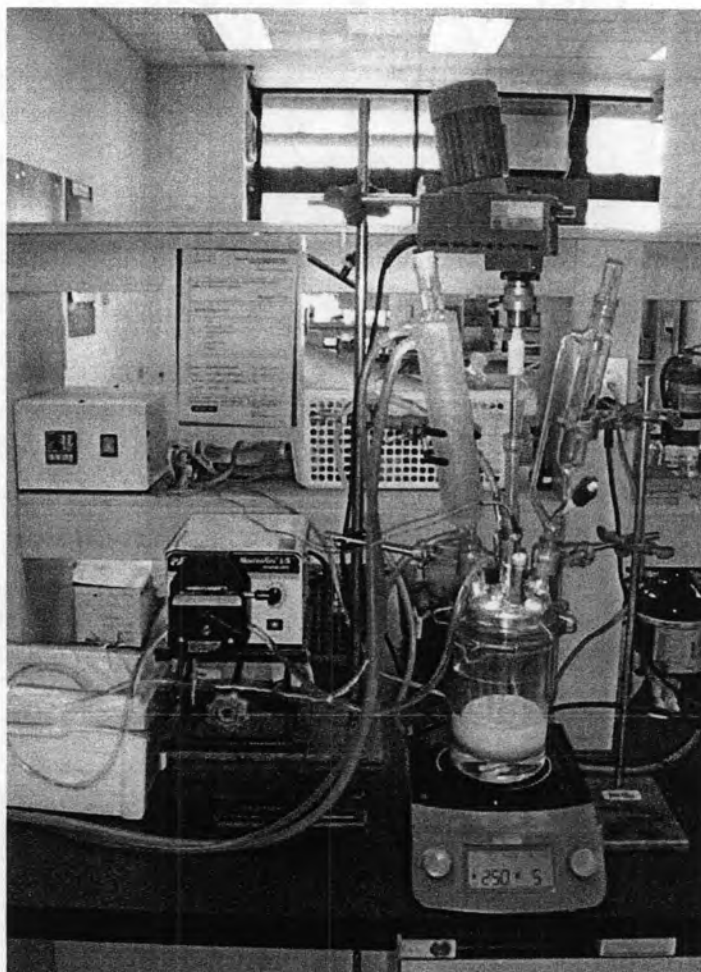

(b)

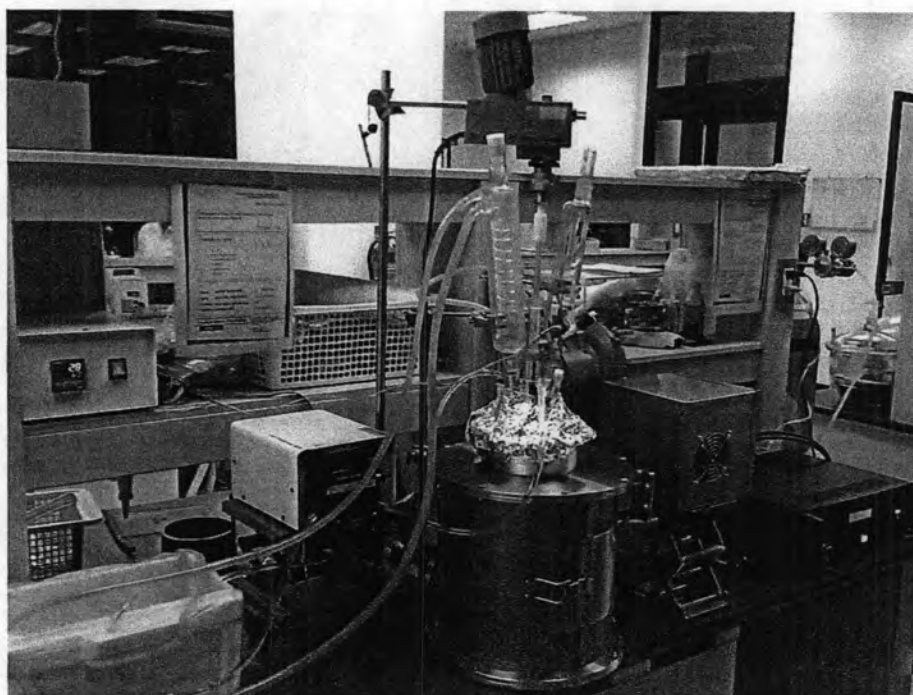

Figure 3.6 Graft copolymerization apparatus for (a) conventional method and (b) microwave method.

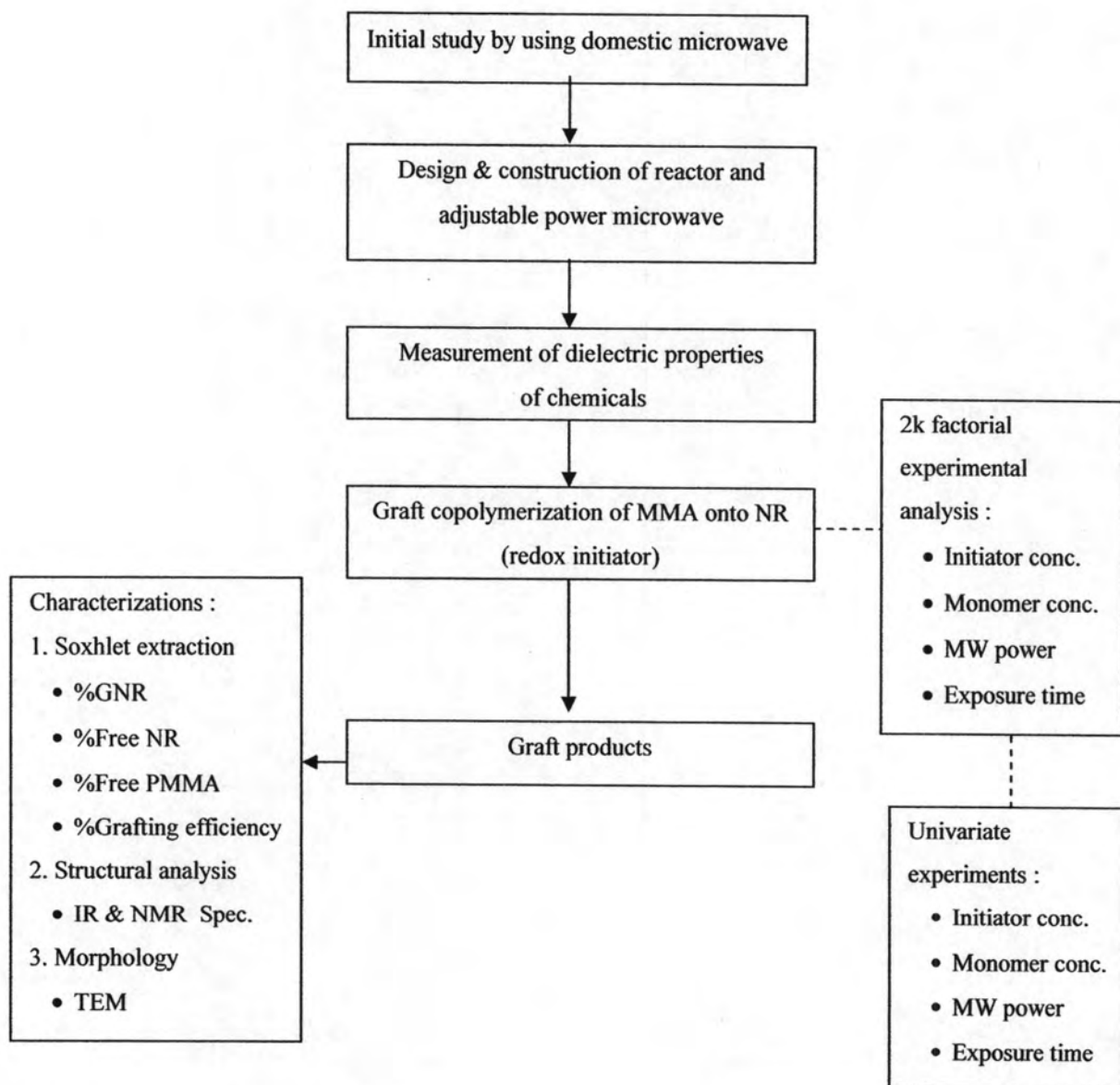

Figure 3.7 Overall experimental process in this research.

Table 3.1 Standard recipe used for graft copolymerization

Ingredients	Quantities
NR latex (60 % DRC)	50 g
Deionized water	250 ml
Buffer (potassium hydroxide)	0.3 g (1 phr)
Surfactant (sodium dodecyl sulfate)	0.3 g (1 phr)
Stabilizer (isopropanol)	3 g (10 phr)
Reaction temperature	60°C
Monomer (methyl methacrylate)	25-75 phr
Redox initiator (CHPO : TEPA = 1:1)	0.5-2.5 phr
Microwave power	50-150 W
Exposure time	5-40 min

3.4 Determination of grafting properties

The obtained graft product consisted of three parts: GNR, free NR (ungraft NR) and free poly(methyl methacrylate) (PMMA). The free NR and free PMMA were removed by using soxhlet extraction with petroleum ether and acetone, respectively. The dried final residue was the graft copolymer of MMA onto NR. The different weight between initial and extracted samples obtained from soxhlet extraction was used to determine the contents of graft copolymer, free NR and free copolymer. All calculations are presented as Eq. 3.3-3.7 and Appendix E (Siriya Angnanon, 2008).

$$\% \text{Total conversion} = \frac{\text{Weight of gross polymer products} - \text{weight of NR}}{\text{Weight of monomer charged}} \times 100 \quad (3.3)$$

$$\% \text{Free NR} = \frac{\text{Weight of free NR}}{\text{Weight of gross polymer products}} \times 100 \quad (3.4)$$

$$\% \text{Free PMMA} = \frac{\text{Weight of free PMMA}}{\text{Weight of gross polymer products}} \times 100 \quad (3.5)$$

$$\% \text{GNR} = \frac{\text{Weight of graft NR}}{\text{Weight of gross polymer products}} \times 100 \quad (3.6)$$

$$\% \text{Grafting efficiency (\%GE)} = \frac{\text{Weight of monomer grafted}}{\text{Weight of monomer polymerized}} \times 100 \quad (3.7)$$

3.5 Statistical analysis using two level factorial design experiments

Factorial designs are generally used for experimental systems involving several factors in order to study the main and joint effects of factors on the response (Montgomery, 2001). Two-level factorial design experiments are widely used to screen the influence of each reaction factor. In this research, the four principal factors which had an effect on the %grafting properties (%GNR, %free NR %free PMMA) and %GE were initiator concentration; INT (A), monomer concentration; MMA (B), microwave power; MWP (C) and exposure time; ET (D). When two-level factorial design was applied to calculate the effect of parameters in the experiment, the levels of factors may be arbitrarily called “low (-1)” and “high (+1)”. The ranges of studied factors are shown in Table 3.2. The statistical model for a 2^4 design includes four main effects, six two-factor interactions, four three-factor interactions and one four-factor interaction. Thus, the complete model for a 2^4 factorial design contains $2^4 - 1$ effects. The general approach to the statistical analysis of the 2^4 design is divided into five steps (Montgomery, 2001).

The first step is to estimate the factor effects and compute the sum of squares for each effect. The contrast associated with each effect is firstly calculated. This can always be done by using a table of plus and minus signs as shown in Appendix F.

Table 3.2 Condition of 2^4 design for graft copolymerization of MMA onto NR under microwave irradiation

Factors	Name	Low level	High level
		(-1)	(+1)
INT (A)	Initiator concentration	0.5 phr	2.5 phr
MMA (B)	Monomer concentration	25 phr	75 phr
MWP (C)	Microwave power	50 W	150 W
ET (D)	Exposure time	10 min	30 min

In general, the contrast for effect “ $ABCD$ ” is determined by expanding the right-hand side of Eq. 3.8.

$$\text{Contrast}_{ABCD} = (a \pm 1)(b \pm 1)(c \pm 1)(d \pm 1) \quad (3.8)$$

Once the contrasts for the effects are computed, the estimate effects values and the sums of squares are calculated according to Eq. 3.9 and Eq. 3.10, respectively (where n denotes as the number of replicates).

$$\text{Effect estimate}_{ABCD} = \frac{2}{n2^4} (\text{Contrast}_{ABCD}) \quad (3.9)$$

$$SS_{ABCD} = \frac{2}{n2^4} (\text{Contrast}_{ABCD})^2 \quad (3.10)$$

For the second step, the 16 experiments obtained from 2^4 factorial design contains main effects and interactions. The third step relates to the analysis of variance (ANOVA) to evaluate the significance of main effects and interaction. Table 3.3 shows the general form of an analysis of variance for a 2^4 factorial design with n replicates. The F test was used to evaluate if a variable has a significant effect. The fourth step is to refine the model by removing any non-significant effects. When the significant effect estimates are obtained, the coefficient estimates are then calculated (Eq. 3.11). The standard deviation (S) associated with the experiment is given by the square root of the error mean square (Root MSE) (Eq. 3.12). The standard error (se) for the effect estimate and the coefficient estimate are then computed according to Eq. 3.13 and 3.14, respectively. These standard errors are used to construct confidence intervals on the effect estimate and coefficient estimate.

$$\text{Coefficient estimate}_{ABCD} = \text{Effect estimate}_{ABCD}/2 \quad (3.11)$$

$$S = \sqrt{MS_E} \quad (3.12)$$

$$se (\text{Effect estimate}) = \frac{2S}{\sqrt{n2^4}} \quad (3.13)$$

$$se (\text{Coefficient estimate}) = \frac{S}{\sqrt{n2}} \quad (3.14)$$

Table 3.3 Analysis of variance for a 2^4 design

Model term	Sum of squares	Percent contribution	Degrees of freedom	Mean square	F_0
Main effects					
A	SS_A	$= (SS_A/SS_T) \times 100$	1	$MS_A = SS_A/1$	$= MS_A/MS_E$
B	SS_B	$= (SS_B/SS_T) \times 100$	1	$MS_B = SS_B/1$	$= MS_B/MS_E$
C	SS_C	$= (SS_C/SS_T) \times 100$	1	$MS_C = SS_C/1$	$= MS_C/MS_E$
D	SS_D	$= (SS_D/SS_T) \times 100$	1	$MS_D = SS_D/1$	$= MS_D/MS_E$
Two-factor interactions					
AB	SS_{AB}	$= (SS_{AB}/SS_T) \times 100$	1	$MS_{AB} = SS_{AB}/1$	$= MS_{AB}/MS_E$
AC	SS_{AC}	$= (SS_{AC}/SS_T) \times 100$	1	$MS_{AC} = SS_{AC}/1$	$= MS_{AC}/MS_E$
AD	SS_{AD}	$= (SS_{AD}/SS_T) \times 100$	1	$MS_{AD} = SS_{AD}/1$	$= MS_{AD}/MS_E$
BC	SS_{BC}	$= (SS_{BC}/SS_T) \times 100$	1	$MS_{BC} = SS_{BC}/1$	$= MS_{BC}/MS_E$
BD	SS_{BD}	$= (SS_{BD}/SS_T) \times 100$	1	$MS_{BD} = SS_{BD}/1$	$= MS_{BD}/MS_E$
CD	SS_{CD}	$= (SS_{CD}/SS_T) \times 100$	1	$MS_{CD} = SS_{CD}/1$	$= MS_{CD}/MS_E$
Three-factor interactions					
ABC	SS_{ABC}	$= (SS_{ABC}/SS_T) \times 100$	1	$MS_{ABC} = SS_{ABC}/1$	$= MS_{ABC}/MS_E$
ABD	SS_{ABD}	$= (SS_{ABD}/SS_T) \times 100$	1	$MS_{ABD} = SS_{ABD}/1$	$= MS_{ABD}/MS_E$
ACD	SS_{ACD}	$= (SS_{ACD}/SS_T) \times 100$	1	$MS_{ACD} = SS_{ACD}/1$	$= MS_{ACD}/MS_E$
BCD	SS_{BCD}	$= (SS_{BCD}/SS_T) \times 100$	1	$MS_{BCD} = SS_{BCD}/1$	$= MS_{BCD}/MS_E$
Four-factor interaction					
ABCD	SS_{ABCD}	$= (SS_{ABCD}/SS_T) \times 100$	1	$MS_{ABCD} = SS_{ABCD}/1$	$= MS_{ABCD}/MS_E$
Error	SS_E	$= (SS_E/SS_T) \times 100$	$2^4(n-1)$	$MS_E = SS_E/2^4(n-1)$	
Total	SS_T		$n2^4-1$		

where SS_T = Total of sum of squares of each effect

$$SS_E = SS_T - SS_{Subtotals}$$

by $SS_{Subtotals} = SS_A + SS_B + \dots + SS_{ABCD}$

The standard error of an effect estimate is twice the standard error of an coefficient estimate in the regression model for the 2^4 design. In the final step, the usual residual analysis is provided to check for the model adequacy (Montgomery, 2001).

3.5.1 Residuals and model adequacy checking (Montgomery, 2001)

Before the conclusions from the analysis of variance, the adequacy of the underlying model should be checked. As before, the primary diagnostic tool is *residual analysis*. The residuals (e) for the four-factor factorial model as shown in Eq. 3.15.

$$e = Y - \hat{Y} \quad (3.15)$$

where Y is the observed values
 \hat{Y} is the predicted values

Model adequacy checking can be done easily by graphical analysis of residuals.

3.5.1.1 Normal probability plot of the residuals

A normal probability plot of the residuals is an extremely useful procedure. In the analysis of variance, it is usually more effective to do this with the residuals. If the underlying error distribution is normal, this plot will resemble a straight line. In visualizing the straight line, place more emphasis on the central values of the plot than on the extremes.

3.5.1.2. Plot of residuals versus predicted values

If the model is correct, the residuals should be *structureless*; in particular, they should be unrelated to any other variable including the predicted response. A simple check is to plot the residuals (e) versus the predicted values (\hat{y}). This plot should not reveal any obvious pattern.

3.5.2 Regression model (Montgomery, 2001)

In a 2^k factorial design, it is easy to express the results of the experiment in terms of a *regression model*. Because the 2^k is just a factorial design, the either an effects or a means model could be used, but the regression model approach is much more natural and intuitive. For any predicted value, the regression model is presented as shown in Eq. 3.16.

$$\hat{Y}_i = \beta_0 + \beta_1 X_1 + \beta_2 X_2 + \dots + \beta_k X_k \quad (i = 1, 2, \dots, m) \quad (3.16)$$

where \hat{Y}_i is any predicted value (i = number of response is available)

X_k is any coded factor (k = number of main effects)

β_0 is the average reponse of 2^k factorial design (y-intercept)

β_k is the coefficient estimates (regression coefficients)

3.6 Univariate experiments

The statistical experiments described above provide only information on the significance of the factors. In order to determine how each variable affected the %grafting properties and %GE, the univariate experiments of the central composite design of the factors were carried out individually in order to determine their influence on the %grafting properties and %GE. The center condition and ranges of studied parameters are shown in Table 3.4.

Table 3.4 Condition of univariate experiment for graft copolymerization of MMA onto NR under microwave irradiation

Effect name	Center condition	Quantities
Microwave power (W)	100	50, 75, 100, 125, 150 W
Exposure time (min)	20	5, 10, 20, 30, 40 min
Monomer (MMA) (phr)	50	25, 40, 50, 60, 75 phr
Initiator (CHPO/TEPA) (phr)	1.5	0.5, 1.0, 1.5, 2.0, 2.5 phr

3.7 Characterization of GNR

After soxhlet extraction, the chemical structure of GNR (NR-*g*-MMA) was evaluated.

3.7.1 Fourier Transform Infrared (FT-IR) spectroscopy

FTIR spectra of the GNR obtained after soxhlet extraction was compared to NR structure by using a Perkin Elmer 2000 model: Thermo 470 FT-IR in the range of 4,000-400 cm^{-1} . The sample was dissolved in chloroform and then casted onto a NaCl disk.

3.7.2 Nuclear Magnetic Resonance (NMR) spectroscopy

The GNR sample was swollen in CDCl_3 (0.01 g of sample in 3-4 mL CDCl_3). The structure of GNR was analyzed by using $^1\text{H-NMR}$. The result from NMR spectra was used to determine the specific functional groups: carbonyl group and acrylic group in the structure of GNR.

3.8 Morphology of GNR

3.8.1 Transmission Electron Microscopy (TEM)

The morphology of the GNR latex was examined by using a transmission electron microscope (TEM) (JEM-2100) and the accelerating voltage was in the range of 160-200 kV. The GNR latex was diluted for 400 times with distilled water to a concentration of 0.05 %wt. In 1 ml of this solution, 2% aq. OsO_4 solution was added and allowed to stain the NR phase in the graft product for overnight. The GNR latex was then placed on a grid and dried before evaluation.