

CHATER IV

Implementation

4.1 Flow concept development

The high volume of production that fixes on one model and output rate, as a batch production is the major problem of the conveyor belt production line. The cellular manufacturing can be applied into the hand mount process and the rest of the processes to solve these current problems. The cells of hand mount process can build the boards in the pattern of the wide variety with small lot production. The long line is shortened causing the reduction of distance so the movement of work is reduced. The board is processed board by board causing the low inventory and short throughput time. The teamwork is built up within a cell to enhance the ownership value in products.

A couple alternatives have been studied to develop the cellular manufacturing into the current conveyor belt line as follows:

1. Standard cell application

The Group technology is applied by use of U-shape layout concept as in the figure 4.1. The U-shape cell could be formed for the whole processes but it cannot fit the current condition. The complete cell application needs a lot of change.

- A big space is needed to convert the straight line into U-shaped line whereas the nearby area is being used for the other production lines. It costs a lot to move all things.
- The capacity and cost of the dip machine is too high for one cell and its size is too big. The space utilization is not worth doing it.

- To increase cells quantity is costly because one cell needs a complete set of Machines/Equipment. The ICT & CBA , Dip machine are costly for investment.

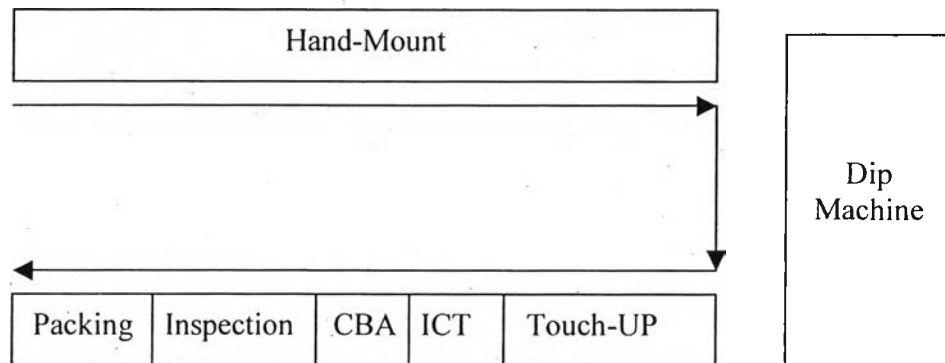

Figure 4.1 : U-Shape layout

2. Process cell application

The new idea is created based on the development of the cellular manufacturing concept into the current conveyor belt line wherever it is appropriate to solve the existing problems. The conveyor belt line is shown in the figure 4.2 and the drawing is in the appendix 3.1. This methodology can be applied to the current production line without any big impact. The process cell application is selected to develop the cell concept into the current line.

4.1.1 Hand mount

The process cell is started at Hand Mount process. This process is the key change in this research because the quality and productivity of the production line are all major contributed by this process. The hand mount job shall be completed within one cell according to the cellular concept. There are 3 major changes to develop the process into cell concept. They are : (1) design cells, (2) design workstations and (3) design material handling system.

4.1.1.1 Design cells

It composes of time motion study and loop Design. The time motion study shall be carried out first in order to support information into the loop design and also for the 2nd and 3rd item that are the workstation and material handling system design.

1. Time and motion study

The micro study in the Hand-Mount process shall be considered at first because the information of this study will be used in the loop, work station and handling system.

The movement to mount one part may give a small impact to the cycle time but one board is composed of 100-200 parts approximately so the impact is huge. In order to optimize the working method, each activity in the hand mount operation has been studied to minimize the non-value added jobs.

Figure 4.3 shows three key activities in the hand mount operation. They are : (1) mounting, (2) refill parts and (3) work in process handling.

1.1 Mounting : these are all motions to achieve in assembling the part onto the board that is also shown in the figure 4.3.

1.1.1 Reach Motion

The current method is to use two hands to move the part in symmetry manner. The eye fixation can be improved. To reach the part box, the Together Movement in the figure 4.4 can minimize one step of eye fixation. This can be proved by Method-Time Measurement (MTM) calculation and study about predetermined usage time in Reach.

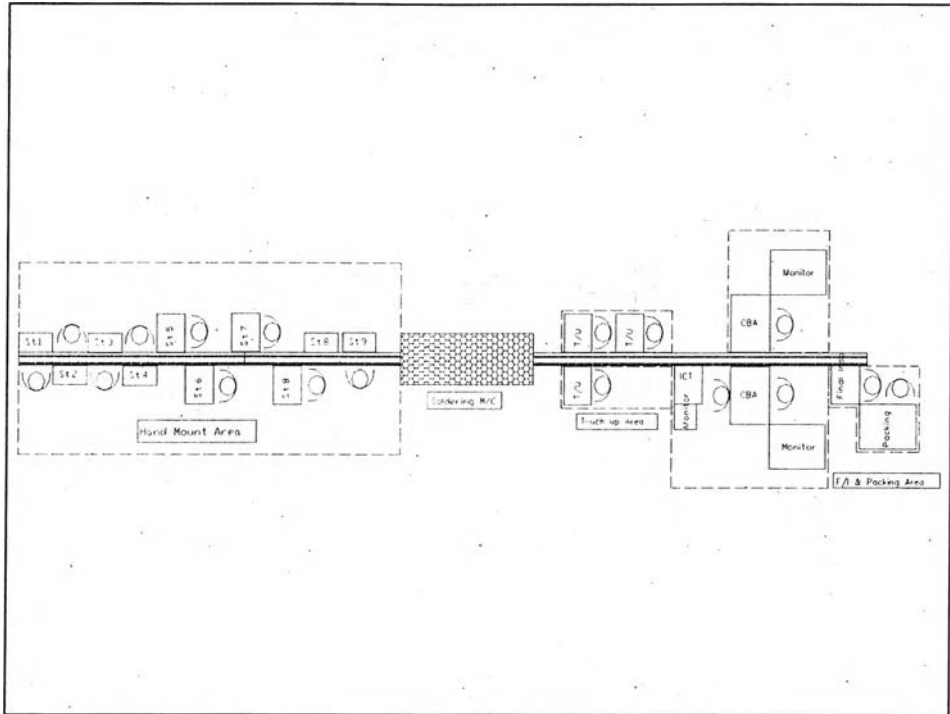

Figure 4.2 : Conveyor Belt Line

1.1.2 Grasp Motion

The part box design shall be easy to grasp the part. The box is made from the scrapped paper carton box of the raw material. The part box is designed to change the shape from the ordinary shape to user friendly design in the figure 4.5. The drawing of part box is in the appendix 4.1. The original package is tried to use as much as possible. The original package that is suitable for use is the one that contains the partition to keep the part individually such as small transformer, transistor or the IC that is kept in the tube. The part is in the certain position that eases for grasping

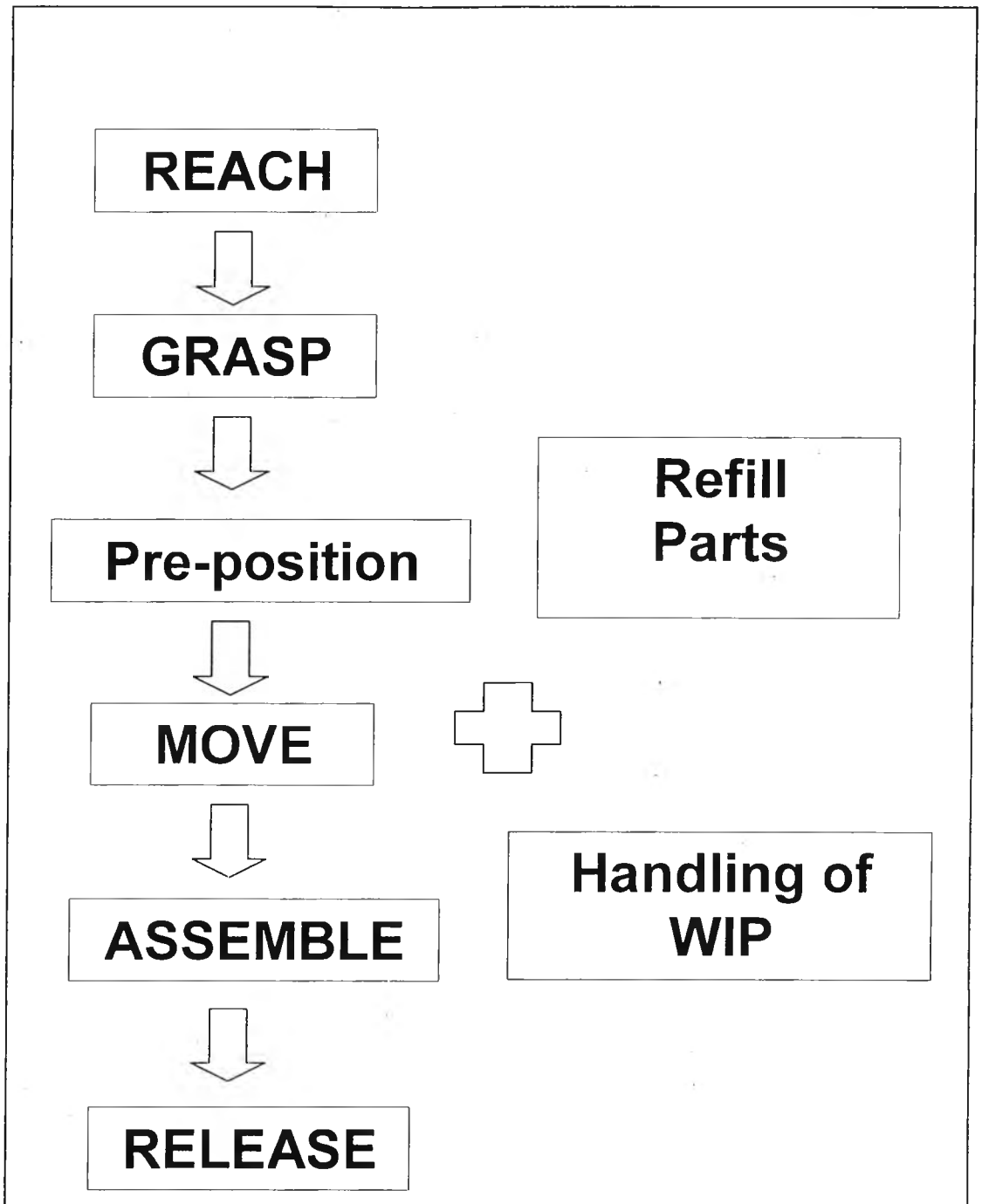

Figure 4.3 : Three Key Activities in the Hand Mount Operation

Method-Time Measurement(MTM)

Symmetrical Movement				Together Movement			
Part box 1,8				Part box 1,2			
Left	TMU	Right	Eye	Left	TMU	Right	Eye
R21.22 D	21.2		ET58.83 /47	R21.22 D	21.2	R19.9 D	ET58.83 /47
	17.41	R21.22 D	ET58.83 /47				

1 TMU = 0.036 sec

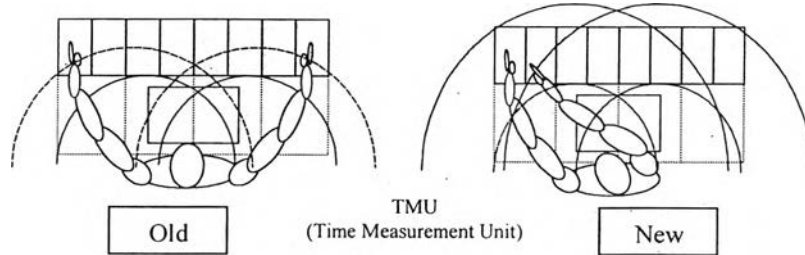

Figure 4.4 : Comparison of New and Old Mounting Method

Original VS Modified

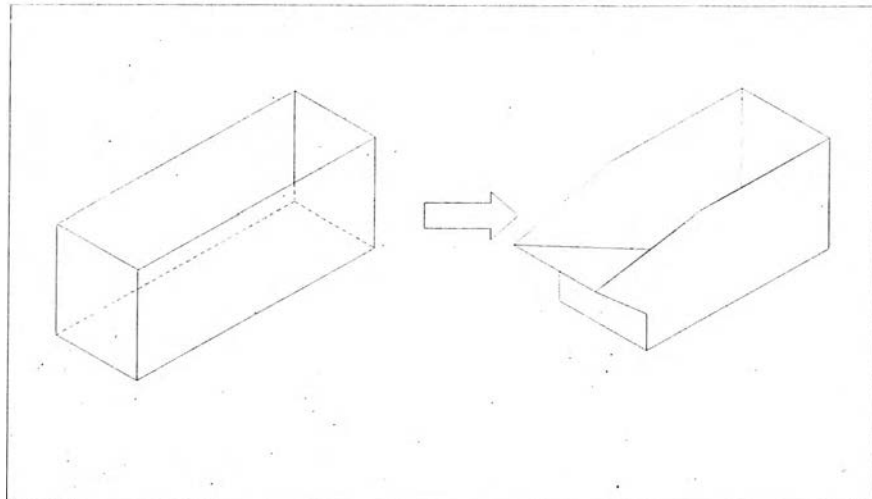

Figure 4.5 : New Part Box

1.1.3 Move

The location of part boxes shall be close to the board as much as possible. The shelf of the workstation shall be adjustable to match the part box. The height of the work bench shall be 5-10 cm below the height of the elbow. The 85 cm high is the dimension of the workstation. The height of the shelf shall not exceed 125 cm

1.1.4 Preposition

The difficult part shall be handled by the right hand. This can be set in the part sequence design.

1.1.5 Assembly

To handle the difficult part by the right hand also eases operator in mounting part onto the board. In addition, the part sequence shall be designed to solve the part obstacle problem. The big part shall be mounted first and then the small part.

1.1.6 Grasp → Release

The release motion is the end of the process so it cannot be modified much. The overall motion shall be considered for the body movement. The natural position shall be obtained as much as possible. The part location that causes uncomfortable movement shall be modified to avoid the wrong movement.

1.2 Refill part : the parts in the box are run out so the operator has to fill the parts into the box. There are 3 points on the current methods that (1) the frequency of refilling parts reduction, (2) idle time of the others operators during one operator refilling the parts and (3) the raw material supply interrupts the operation
The improvement activities are shown in the table 4.1.

1.3 Work in process handling : the operator has to pass the semi-finished goods to the next the operator once the job of own station is finished. There is a point in terms of WIP movement that the flow shall not have any back tracking.

2. Loop design

The loop design shall conformed to the following ideas.

- Process flow

The flow shall be smooth. It shall minimize waste from the process itself. The process shall be flowed in one direction without any back tracking in the flow.

- Material flow

The material shall be supplied to the cell with less handling or any interruption.





- Information flow

The quality information shall be obtained as quick as possible in order to stop the high failure rate and take corrective action timely.

Hand mount loop Design : Model 28FX60 :

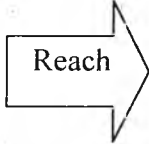
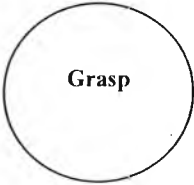
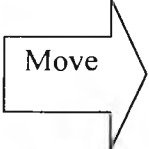
1. Same as item 1 in process design for conveyor line.
2. Same as item 2 process design for conveyor line.
3. Calculate manpower from required quantity and standard operation time from item 2.

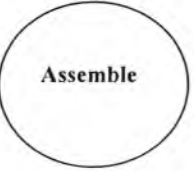
Table 4.1 : Summarized activities of Time & Motion Study

Motion	Improvement Activities
	<ul style="list-style-type: none"> • Change Symmetry Movement to Together Movement
	<ul style="list-style-type: none"> • Part box design shall be easy for Grasping • Use original package as much as possible
	<ul style="list-style-type: none"> • Locate part boxes close to assembly area • Part shelf shall not exceed 125 cm high
	<ul style="list-style-type: none"> • Left/Right hand utilization appropriately
	<ul style="list-style-type: none"> • Part sequence design improvement • Left/Right hand utilization appropriately
	<ul style="list-style-type: none"> • Minimize the stepping & turning of operators
<p>Refill Parts</p>	<ul style="list-style-type: none"> • Design big part box for the big part • Use indirect operator to refill parts to avoid idleness of direct operator • Set refill part system to avoid operation interruption
<p>Handling of Work-In-Process</p>	<ul style="list-style-type: none"> • The flow of job must be one direction only without backtracking

3.1 Manpower calculation

Required quantity	= 500	boards/day
Standard operating time	= 7.293	minutes
Operating hour	= 8.5	hours/shift
Efficiency	= 90%	Higher than Conveyor Line
Manpower	= $\frac{500 \times 7.293}{8.5 \times 60 \times 0.90} = 7.94 \approx 8$ persons	

3.2 Determine the number of loops

This is the stage to set the loops. To make the operation more flexible in capacity and minimize handling loss, the 2 loops design shall be the reasonable to absorb the fluctuation of the expected capacity. The process of hand mount is designed at 250 boards/shift by using 4 operators.

4. This is the same as item 4 of the conveyor belt type to make 2 copies with color mark-up for grouping parts.

Calculate the average cycle time from the number of manpower from item 3
 Average cycle time = $7.293/4$ minutes. This is to calculate the part quantity for each operator

5. To divide the board into portion the same as item 5 of the conveyor line type but this is only horizontal area only as shown in the figure 4.6.

6. The parts are sequenced referring to mount drawings from item 4 and sample board.

All items are designed the same as process design of the conveyor line but the cell line allows more flexibility in the constraint of part sequence. The figure 4.7 shows the

advantage of the series' sequence in cell design. The more detail is discussed in item 4.1.1.4.

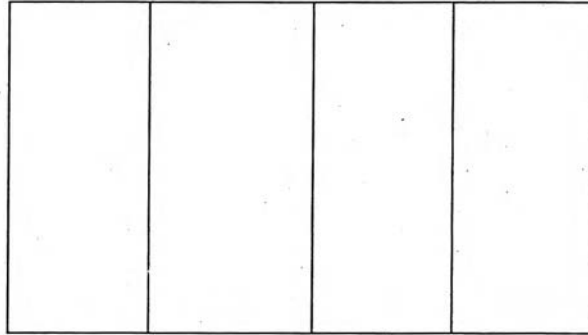

Figure 4.6 : Mounted Zones (Cell Type)

According to the rules above, we will get the part sequence and operator location described by the work instruction in the appendix 4.2.

4.1.1.2 Design workstations

The part shelf is necessary for the cell operation to contain the electrical/semiconductor parts and ease operators to work efficiently. The dimension of part shelf shall be appropriated for human movement based on ergonomic design. The shelf design shall be standardized for other models.

- The height of the part shelf shall not exceed 125 cm that is average height of the shoulder.
- 3 layer of shelves with 30-40 part boxes
- The box design shall be convenient for operators to grasp the parts

The standard workstation of the hand mount is shown in the figure 4.8 and its drawing is in the appendix 4.3.

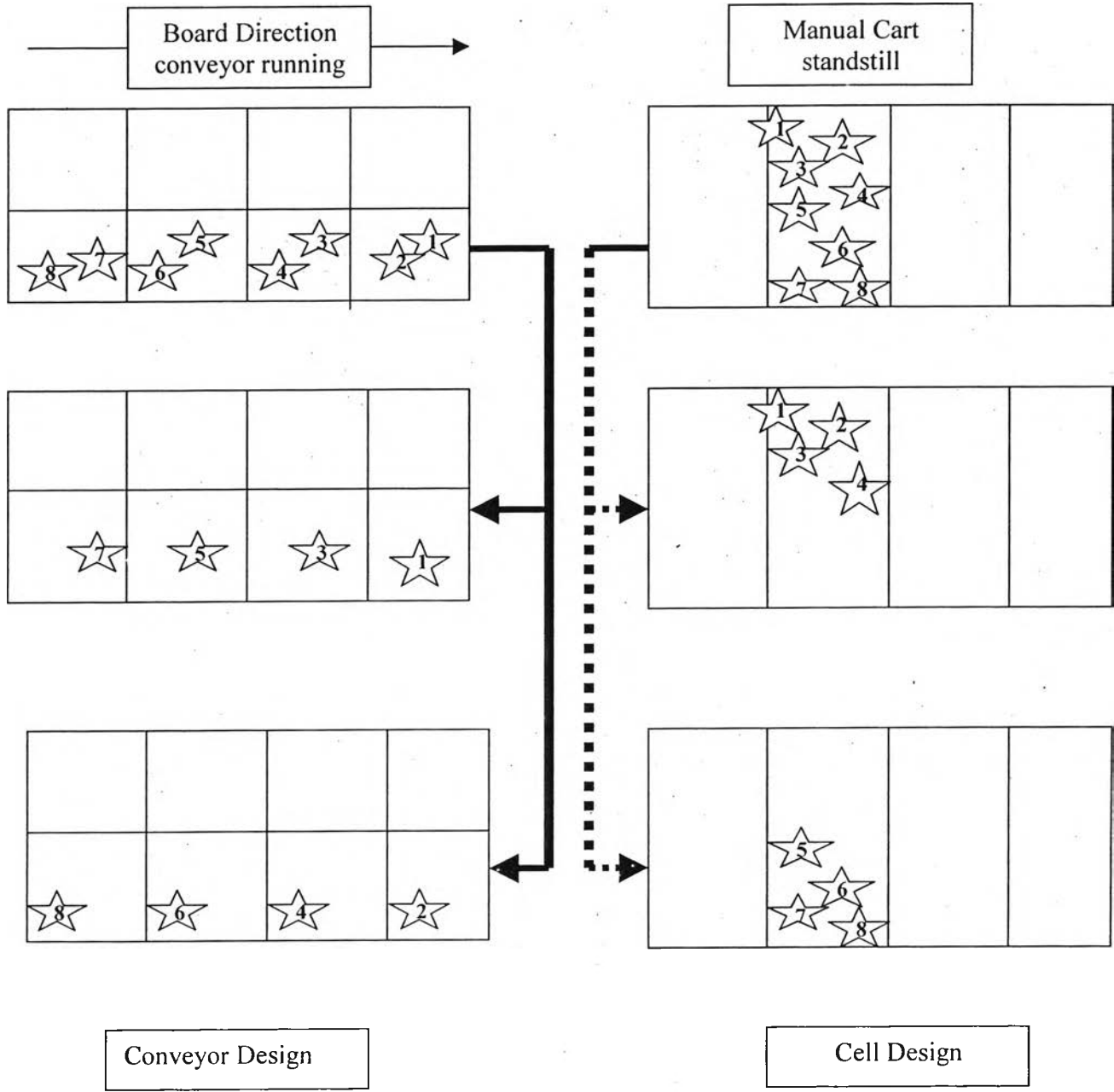

Figure 4.7 : Sequence Comparison between Conveyor and Cell design

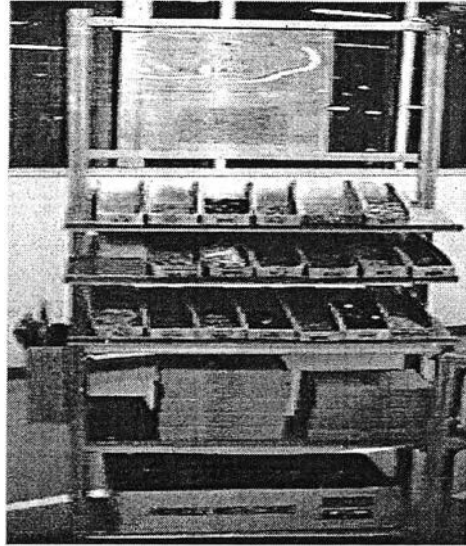

Figure 4.8: Standard Workstation

4.1.1.3 Design material handling system

1. Internal cell handling

There is no conveyor belt to carry the board from one operator to the next operator. The movement of the board between operators can be accomplished by the manual cart.

- The work bench shall be 5-10 cm. below the arm. The height of cart shall be at 87 cm.
- The cart shall have a center bar to prevent warping board during mounting
- The cart shall be run smoothly without shaking

- The board carrier is needed to transfer the board from the cart to the conveyor belt. This is one part of the manual cart that affects to the mounting quality.

The cart/board carrier drawing is in the appendix 4.4.

2. Raw material supply

The operators have to refill the parts into the boxes. During the refilling parts, the flow of Work In Process is stopped causing the high waiting time of all operators within the loop. This job shall be handled by indirect operator. The appropriate system to refill the parts without interruption of operation shall be set up.

As above-mentioned, the refilling parts shall be assigned to the indirect operators. To enter the loop for refilling the parts disturbs the operators who are working. The work station is modified to allow the parts supplied from outside loop. This can be done with activities as follows:

- The part boxes shall be modified to be bigger for holding more parts to reduce the refilling frequency.
- The boxes shall be long enough to be refilled at external loop
- The work instruction shall have double sides to ease operators reading from internal and external loop

The part box design has been changed from the short type to the long type as in the figure 4.9.

Short VS Long type Part Box

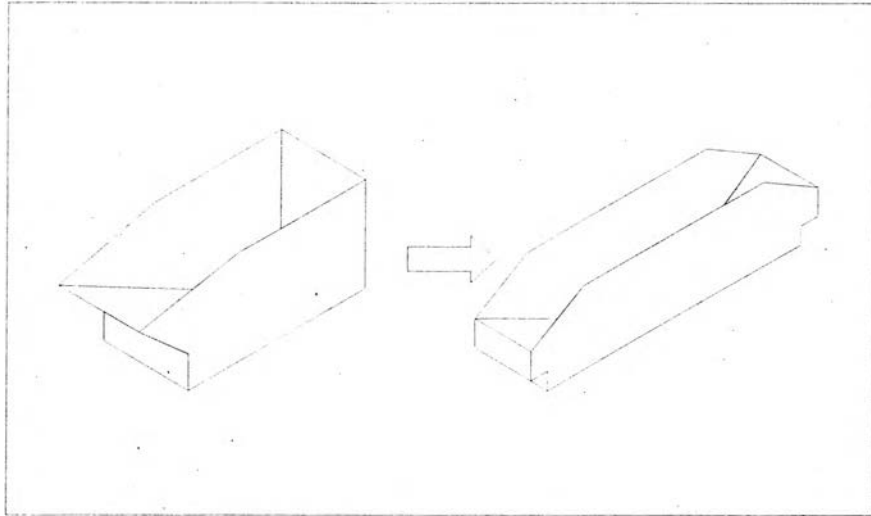

Figure 4.9 : Short VS Long Type of Part Box

The drawing of the new part box is in the appendix 4.5.

4.1.1.4 Flexible part sequence

The part sequence of the cell line is flexible and gain benefit as shown in the figure 4.7.

1. Flexibility

The sequence of cell line is more flexible to change as shown in the figure 4.7. If the job needs to be separated to increase the output rate, the part sequence of the conveyor line is totally changed from 1,2,3,4,5,6,7 and 8 to 1,3,5 and 7 for the 1st operator and 2,4,6 and 8 for the 2nd operator whereas the sequence of the cell design is still the same. The new part sequence needs to be re-designed overall hand mount process if it is not simple case. This is the time consuming task and workstations need

modified to fit the new part sequence. The cell operation can be changed without any big change in real time manner.

2. Waste movement

The board is standstill for the cell line so the parts can be mounted in one column instead of 4 columns evenly as shown in the figure 3.2. This can minimize the move and reach motions.

3. Quality improvement

If there is a case to change the part sequence to improve the mounting error, the change can be applied quickly because it does not have any impact to the total part sequence of workstation.

Another benefit is that the small area (one column) is easy to remember for a operator causing shorter learning curve & less workmanship error.

4. Simple operation

The parts are sequenced small area by area, from top to bottom and from the left to the right of the operator. This is more comfortable for operators in always having the same pattern in mounting and this movement can be carried out by nature because it is the same as of writing a book.

The direction of the board towards operators is the same and the board is set in the way that operators can read the alphabet on the board, not upside down.

4.1.1.5 Advantages of hand mount process (cells)

- Jobs can be allocated to adjust the out put rate without the impact of

overall operation.

- The line balance can be maintained easily by rearrangement of the jobs according to the skill level of each operator
- The operators can work at their full potential without the limit of the conveyor belt
- The quality information can be flowed internal cell quickly. The last operator who lay the board on the belt can inform the quality issue to the members of the cell
- The cells are independent to each other. The quality issue of one cell does not cause the total production stoppage. This is to reduce the risk of line down.
- Parts can be supplied all the time without interruption of the mounting operation.

4.1.2 Dip machine

The dip machine is difficult to be moved due to the space constraint. In addition, the re-located cost is expensive due to the cost of facilities' modification. This process is remained the same as current condition

4.1.3 Touch up

The process of touch up needs to be modified to minimize the movement waste. The conveyor belt is taken out. The manual slide is introduced to allow operators working on the rail and slide the board to the next operator once finish the own job. The manual sliding is shown in the figure 4.10. The drawing of the touch up workstation is shown in the appendix 4.6.

The handling is minimized. The huge inspection job is divided into small operations causing fewer complexes. The board is divided into zones and assigned each operator to inspect for each zone. This is to increase the detection ability of the operator.

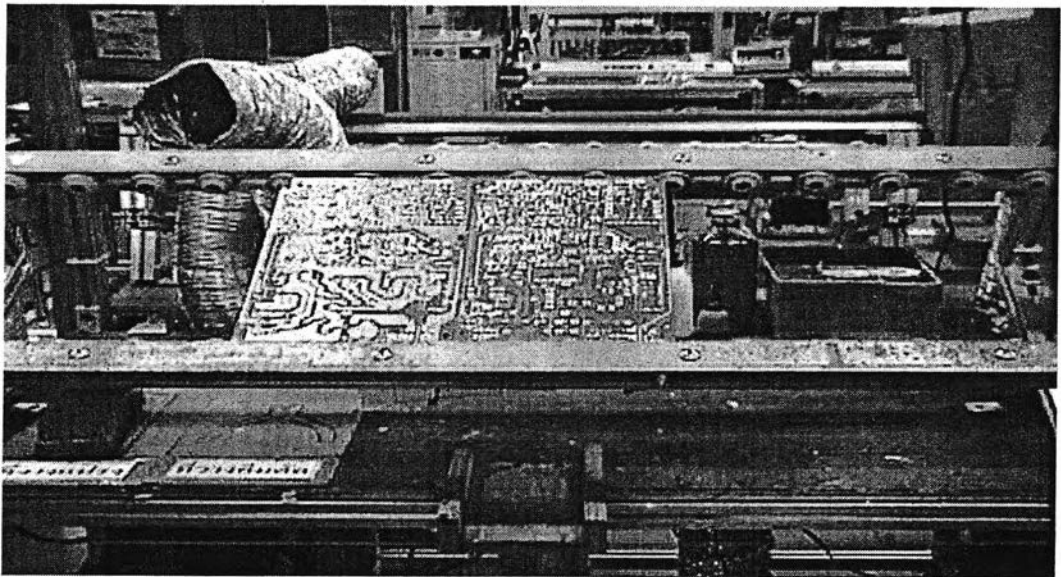

Figure 4.10 : Manual Sliding Rail

4.1.4 In-Circuit-Test (ICT)

4.1.5 Circuit-Board-Adjustment (CBA)

The ICT & CBA can be combined as a loop and take the conveyor out of the line.

4.1.6 Final inspection

4.1.7 Packing

The Final Inspection and Packing process can be rearranged as a group so the flexibility between processes can be increased. The multi-skill operator is developed. The space & WIP is reduced.

4.1.8 Summary of New Cell Concept

The whole new line concept can be described in Figure 3.4. There are 4 key changes in the new Cell Line as follows :

1. Hand-Mount has been changed from the long line conveyor belt into cell loops.

2. Touch-Up has been changed from individual workstation with the conveyor belt to series operation with manual slide on rails.

3. ICT & CBA are combined as the cell loop without conveyor belt.

4. Final Inspection & Packing has been grouped to optimize the space and job balance

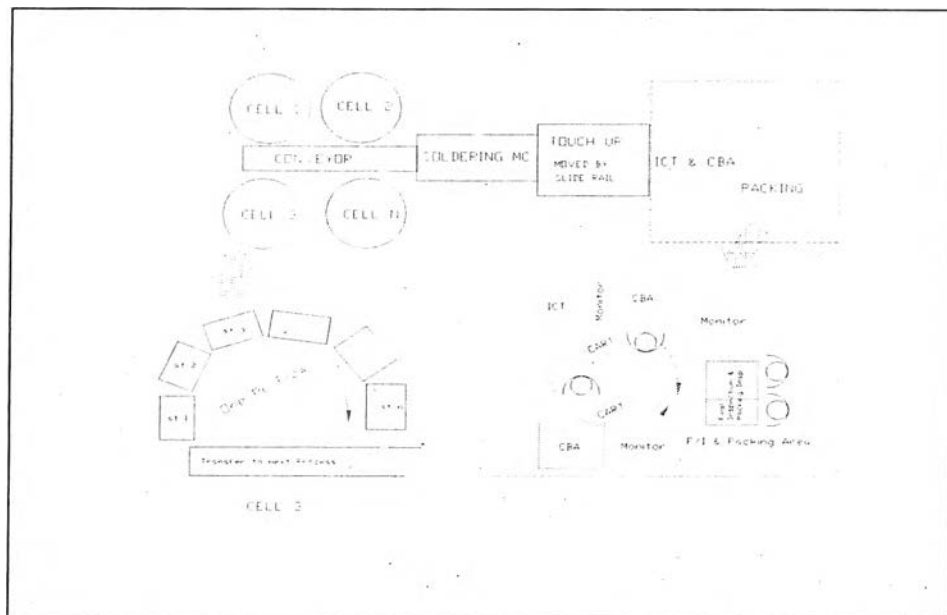

Figure 4.11 : Concept of PWBA Cell Line

The drawing of this new cell concept is shown in the appendix 4.7.

4.2 Draft new layout plan

The actual line has been studied for the actual change. The line layout is shown in the figure 4.12. The drawing of the cell line is shown in the appendix 4.8.

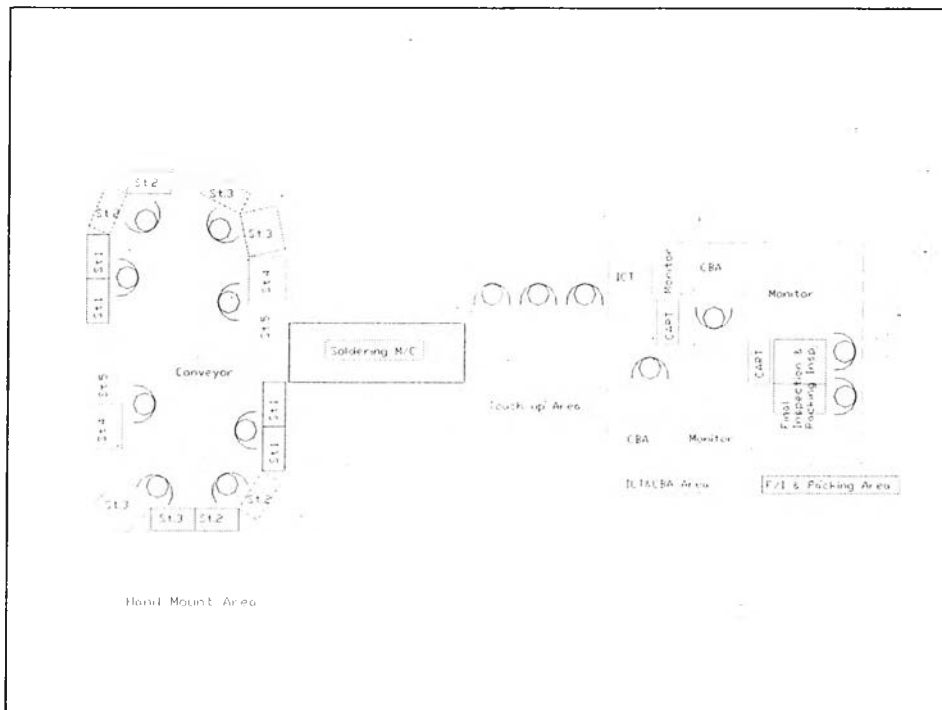

Figure 4.12 : Layout of PWBA Cell Line

4.3 Development Result Estimation

The estimated development result shall be defined and reviewed if there is any opportunity to improve the new line. The estimated result could be described as followings.

1. Flexibility

The production line shall be able to run the product at various output rate without much impact to the productivity.

Hand mount process : the new line can serve this purpose by setting 2 cells of Hand-Mount process. It can be operated at 50% of output rate through one cell. In addition, the one-man-operation can be applied into cell. One operator can perform the job by walking around the cell. By this way, the output rate can be variable.

Dip machine : there is no effect in this machine job.

Touch up : this process uses the one-man-operation concept so the number of operators can be reduced to match the desired output rate or increase operator number in series to increase the output rate.

ICT & CBA : this is a small cell loop. The number of operators also can be reduced to match the output rate.

Final inspection : this is one-man-operation so the number of operators can be adjusted to match the output.

Packing : the number of packing operator can be adjusted to match the job load as this is a manual job that can be re-arranged.

2. Quality

As the processes are run by manual movement, the operators don't get the pressure of speed belt. The standard inventory can be set in between process to minimize Work-In-Process. The production line is easy to be stopped once there is any quality issue causing over-standard inventory.



3. Autonomous line balance

The multi-skill operators can assist one another so it can eliminate the bottleneck automatically within a cell.

4. Teamwork

The cell can build up the team spirit. As a cell loop, the operators within a cell are likely to have more ownership in their output. This will lead a continuous improvement.

5. Just-In-Time concept

This can prevent the huge Work-In-Process because it can be visualized the production line status. If there is any trouble spot, the upstream process is stopped so that the WIP are not piled up and the stoppage of the line can draw the attention of all concerned people to fix the problem that can reduce the downtime.

6. Eliminate model changeover loss

The model that is in the same family can be run in the same production line. As this research designs 2 cells of Hand-Mount process, the 2 models can be run in parallel at Hand-Mount process whereas the other processes are common use of equipment & operator-skill.

As the expected result can achieve the stated problems in the Chapter III, the implementation can be proceeded.

4.4 Implementation

1. Team training

The training concept is to focus on the multi-skill operators, Each operator shall be able to do more than one job. There are 4 groups that shall work together.

- Hand mount : all operators within a loop shall have capability to work in any station. The one-man-operation shall be trained so that the operator can mount the whole parts onto the board. This is necessary for the reduced production timing.

- Touch up : operators shall be able to inspect the whole area of the board.

- ICT & CBA : operators shall work on both process because this is a one-piece- flow process.

- Final inspection and packing : this 2 functions shall be flexible to help each other.

The concept of this cell operation shall be explained to all operators to understand the new culture of working. The job is not fixed the same as the conveyor belt style. The teamwork is the key to success in this operation.

Once the operators are trained for the multi skill operation, the job rotation shall be established to brush up their skills.

2. Communication

The daily morning meeting activities shall be set to ensure that all concerned parties are well informed in order to achieve the production target smoothly. All issues have to be highlighted for the production line preparation. The agenda shall be as follows:

- Planning : the customer information shall be shared if the plan needs changing

- Material : the availability of material is reported and any critical parts that may be in shortage shall be informed.

- Quality : the quality of product shall be alert if there is any critical issue or related to the stop shipment.

- Production : the production plan shall be confirmed. If there is any proposed change, all related functions have to be the difficulties of production shall be raised to get support from concerned parties and follow up any pending issues to ensure the smooth run.

3. Standard stock control

The Work-In-process shall be controlled in between processes. The limit of WIP is defined to set the standard condition of the production line. The visual control is the concept in Just-In-Time management. This can be achieved by the activities as follows:

- The signal light shall be installed between the hand mount loop and touch up station as shown in the figure because the Dip machine is located in between these two processes causing the difficulties in communication. The purpose of the light is to inform

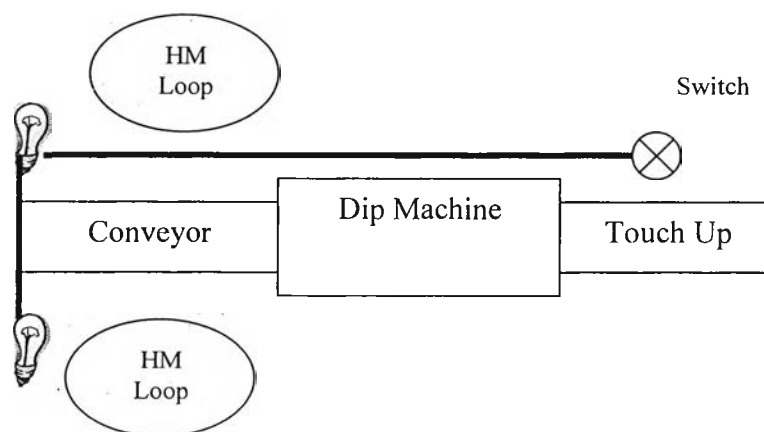

Figure 4.13: Signal Light

the hand mount operator to stop supply the board in case that the output board of the touch up reaches the standard stock level.

- The other processes can be controlled visually by the cart. The cart is designed to have the number of slots to hold the boards as needed. The cart for holding boards is shown in the figure 4.14.

5. Operation implementation

The production can be run at various output rate in Table 4.2..

Table 4.2 : Manpower & Line Out Rate

Line Out Rate	Hand-Mount	Touch-Up	ICT & CBA	Insp. & Packing
500 boards/day	2 loops:8 persons	2	3	2
250 boards/day	1 loop : 4 persons	1	1.5	1
60 boards/day	1 person	As balance	As balance	As balance

The production can be varied from 60 boards per day to 500 boards per day. The one man operation can be applied to get minimum output at 60 board per day at Hand-Mount process. The other processes can be managed by the one-man-operation too for line balance. At 50% of the maximum capacity can be obviously arranged the line by half of manpower for each process.

The actual production has been run at maximum capacity in Jan 2001 at 500 boards per day by 15 operators. In Feb, the requirement has been reduced from 500 boards/day to 160 boards/day. This fluctuation of the market demand can be still supported by the cell operation. It can be achieved by 4.5 operators.

The hand mount process used 2.5 operators as one-man-operation and another 0.5 operator is utilized to support indirect jobs that are excluded in productivity calculation. The other 2 operators work on the rest of the processes. The operation is highly flexible to produce the small quantity per day without critical impact of productivity.

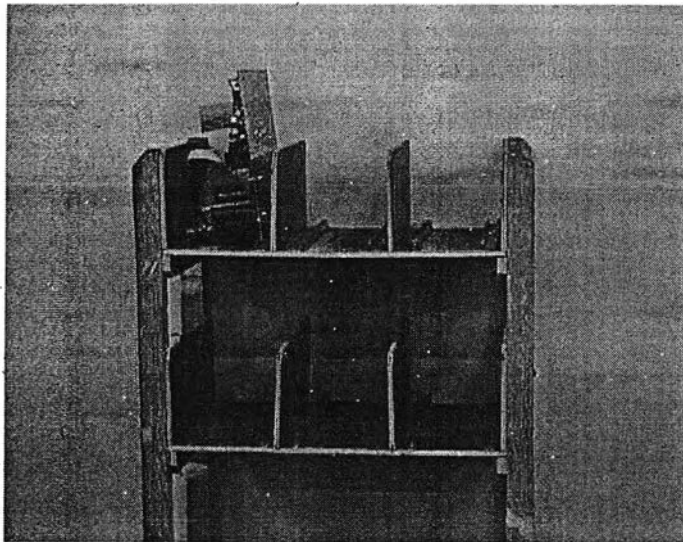

Figure 4.14 : Cart for Holding Board