

CHAPTER V

DEVELOPING A QUALITY CONTROL SYSTEM

5.1 INTRODUCTION

In manufacturing process, the purpose of developing the quality control system, which step by step of process would be enable the inspectors to evaluate the occurring defects, is to provide a quality cost system. This system would be settled by depending upon customer agreement, which was containing within the customer's contract. Whenever the process and quality system had changed, the company had to ask for a permission form them.

According to the customer agreement, the company must provide a group of quality organization, which was separated independently from any departments and the job descriptions and job qualification should be provided clearly including the number of person using for supporting all quality activities. In addition, the quality specification should clarify as customer's product protocol and translate into a quality manual.

To achieve those agreements, the company decided to study all above requirements and especially for implementation. Besides, the initial investment also was contemplated as a part of the studies, which will be discuss in this chapter.

5.2 OVERVIEW TO QUALITY CONTROL SYSTEM

By theoretical concepts, the definition of control process is the process employed in order to meet standard and observing actual performance, comparing performance with the standards. This also including the process of taking actions if the observed performance is significantly different forms the standard. In addition, the control process is to feedback and response the problems and all quality information as shown in figure 5.1.

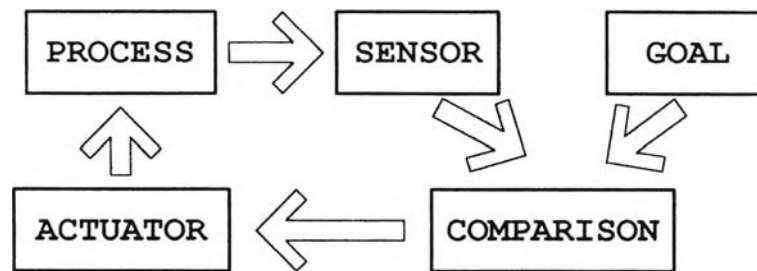

Figure 5.1: The Quality Control loop

In term of quality cost, quality control is a very important step, since it helps to create all of quality information and to translate them into the cost. The first step of the quality control is identifying the sensor, which acts as a measurement to verify such as the process, product and etc. In addition, the good sensor also gives useful information to improve the existing process.

Besides, most sensors are designed to deliver all required information in term of measure. Within the manufacturing process, the sensors were determined by referring to information such as the inspection stations, product specification and etc. The following were the 11 questions, which was used for interpreting them to be the sensors. The questions were:

- 1) Where the area, which need to be performed.
- 2) What the process standards are.
- 3) Who is responsibility for control.
- 4) How to measure.
- 5) When it measures.
- 6) How to report routine data.
- 7) Who is responsible for data reporting.
- 8) How to audit.
- 9) Who is responsible for audit.
- 10) What to do with product out of compliance.
- 11) Who developed the standard.

5.3 IDENTIFYING THE PERFORMED OPERATION

This was the first step for studying quality control system providing to evaluate external requirement (Product protocol) comparing to existing performances. This step that was to find out the area need to be implemented the quality. It started

with analysis of product and its manufacturing processes and determined the inspection area.

Firstly, the studied products in this paper are such as Marinator, Display unit, Burger Station, Holding Cabinet and French Fries Station. Each of them has similar manufacturing operations that are cutting, Layout/CNC, Bending, Assembly, polishing and Techniques except refrigeration system assembly because of no refrigeration system.

In this step, the initial attempt was the analysis of external performance requirements, since the most important thing was customer's agreements. The following figure shows the model is used for this study.

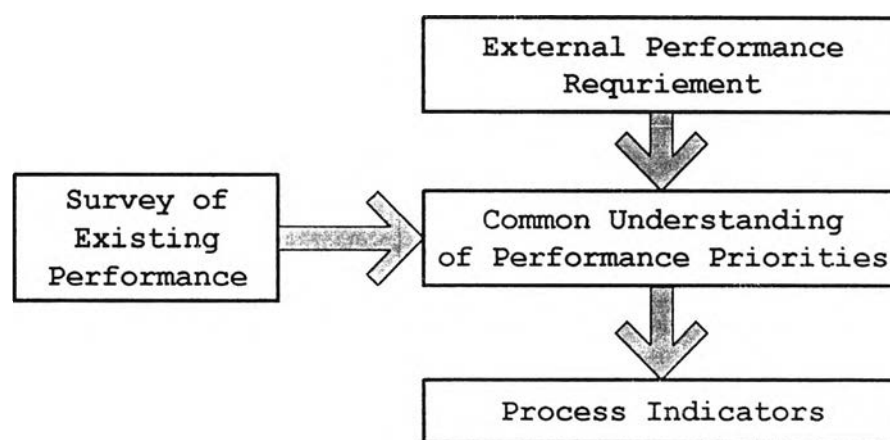

Figure 5.2: Process Indicator

5.3.1 Analyzing Product Requirement: Customer prospect

Referring to the product protocol, the requirements are separated into 2 focusing points that are non-technical and technical configurations. The former involves the cutting, Lay-out/CNC, Bending, Assembly and Polishing operations, while the latter is directly effects to the technical Assembly operations. The non-technical is mostly the same specification, even through the products are different. Whereas the technical configuration that the product specification is various upon the products. For example: the French fries station have to hold the product under the minimum at 82.2 °C within 15 minutes, while the Burger station have to warm the product at 82.2 °C +/- 2 °C within 30 minutes. Those specifications depended upon their functions.

In this paper, the French-Fries station was discussed as an example of analyzing product requirements.

5.3.1.1 Introduction to French-Fries Station

French Fries Station is a crucial and essential equipment for the Fast Food restaurant. It provides the right environment to hold French-Fries, with well-controlled levels of heating, so as to maintain the desired product quality throughout the holding period. The figure is shown in figure 5.3.

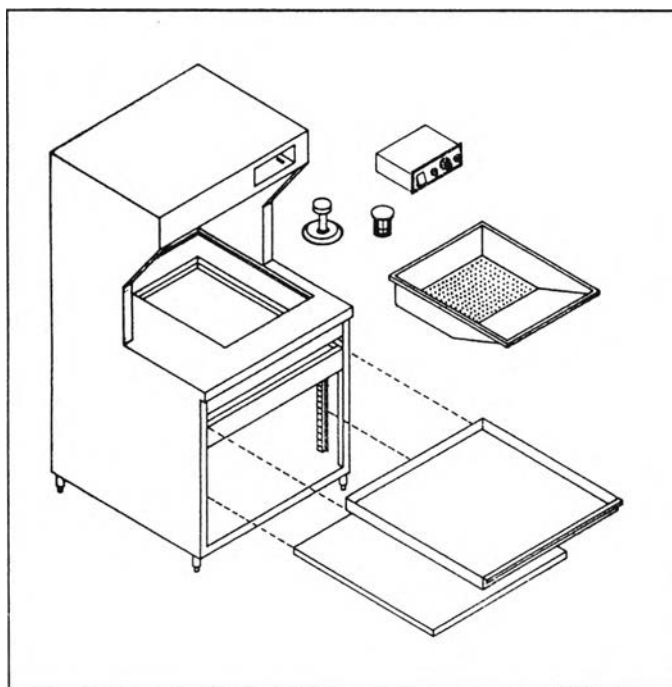

Figure 5.3: French-fries station

Owing to its important, plenty of evaluations and tests are needed to ensure that the unit meets the required standards and specification during the processes and finished products.

5.3.1.2 Product requirements

The product requirements are separated into 2 types: non-technical and technical requirements. In term of non-technical requirements, they are grouped into 2 categories:

1) Raw material specification

There is such as the types of stainless steel and finished surface as well as electrical part and etc. Each of them is identified the specifications, for example: the stainless specification is surface types (the number of 2B, HL and

BA). Also be a providing, its thickness (BWG# 16, 18, 22) that depended upon the strengthen requirement. The lower number of thickness, the stronger strength is obtained.

2) Process control's specification

There is a providing of the quality control standard of cutting, layout, CNC Punching, Bending, Assembly and Polishing. Most of them came from JIS standard and ANSI Standard including NSF standard. The specification is discussed further.

In case of technical requirements, they are divided into 2 parts: Exterior temperature test and Product temperature test. Both of them is to determine exterior surface temperature of the body the French-Fries Station and to determine the product temperature during the holding period, respectively under the ambient temperature is 25 ± 5 °C. This is also discussed further.

3) Exterior temperature test

Under this test, the product will be positioned with 29 thermocouples and operated for 6 hours, next to measure the temperature. The temperature allows not exceeding 65.5 °C. The figure 5.4 shows the 29 positions on the product.

4) Product temperature test

The test is conducted with using cooked French-Fries, which is hold for 15 minutes and the French-Fries temperature would be exceed 56.7 °C. The figure 5.5 shows how to put the thermocouple into the cooked French-Fries.

5.3.2 Existing performance analysis

As mention earlier, the current performance measurement in manufacturing process did not have any implementation of quality system, resulting to the quality information had not been ever distinction. However, the company has provided some measurements in manufacturing process that are employee attendances, product manufacturing time and its costs.

In addition, the attendance evaluate from the number of working day comparing to total company's working day, where as the manufacturing time and cost was recorded from the total man-hour, which were used for producing the products.

In short, the current measurement does not have quality measurement, but it totally emphasized on cost, not quality.

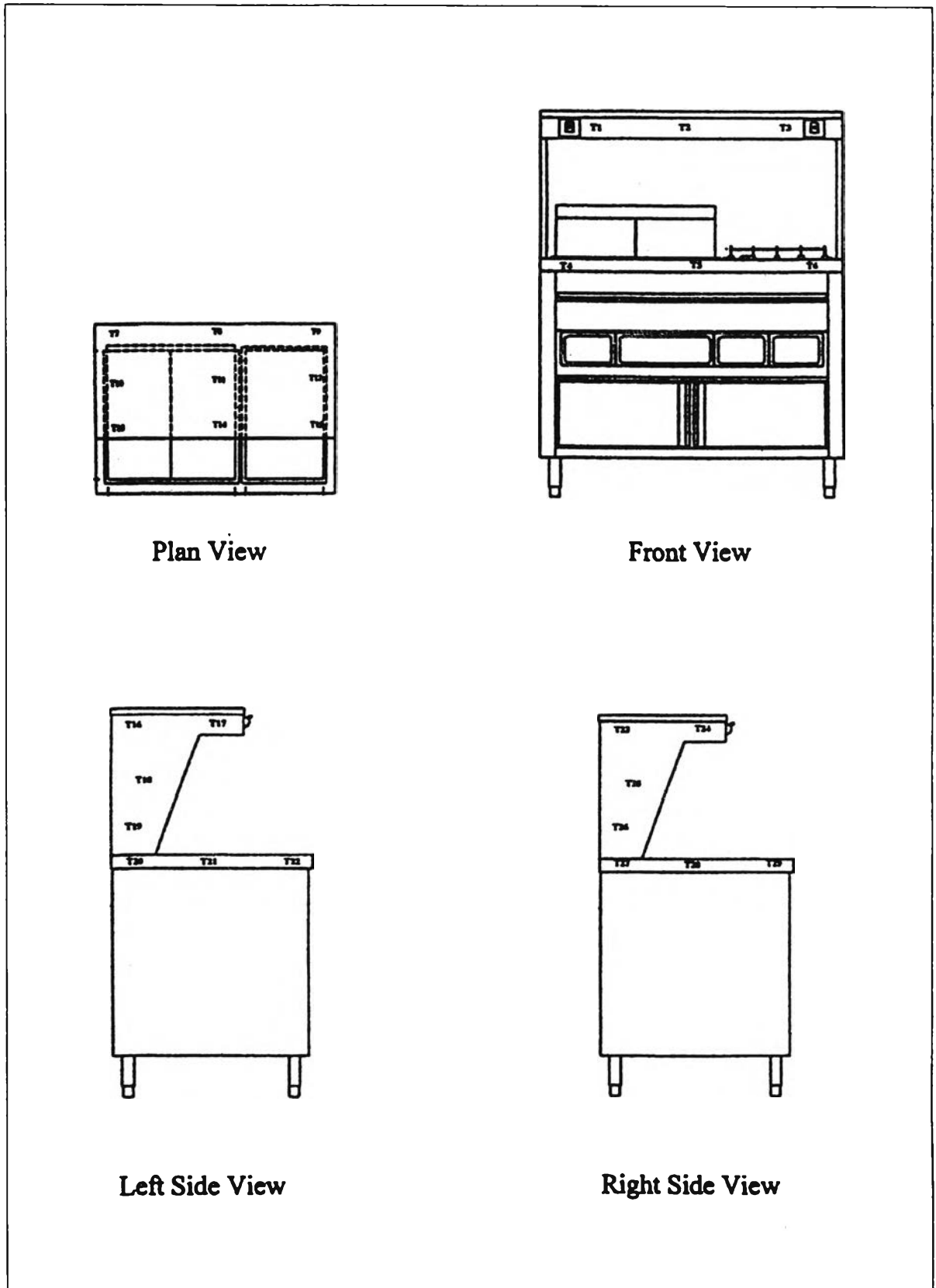

Figure 5.4: The locations for exterior surface temperature measurement

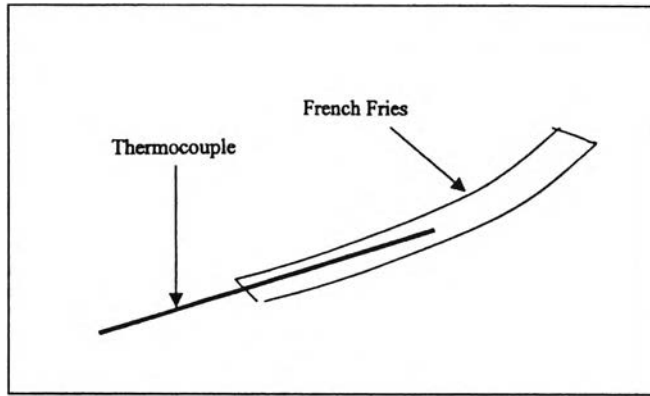

Figure 5.5: Installations of thermocouple in French-Fries

5.3.3 Quality control area

Analyzing the quality requirement, the following process flow is illustrated the quality control station.

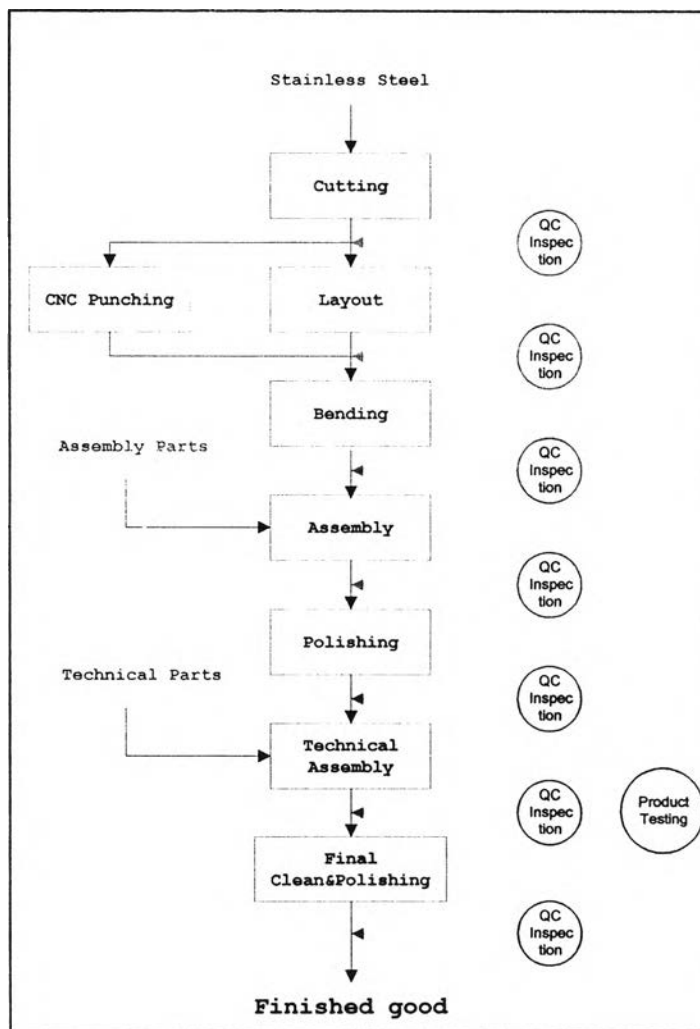

Figure 5.6: Manufacturing process flow

5.4 PROCESS SPECIFICATIONS

The specification of process could be identified as following table.

Table 5.1: Process specification

	Machine type	Process description	Sampling Techniques	Inspection description	Specification	Inspection Equipment
Cutting	Cutting machine	- Cutting the stainless sheet	Sampling MIL 105-E	- Width and length	± 2 mm.	- Meter tape
				- Each corner has right angle	Perpendicular angle ± 1 degree	- Perpendicular measurement
CNC	CNC Punching Machine	- Punching some of cutted sheet	Sampling MIL 105-E	- Diameter	Dia 1 mm.	- Meter tape
				- Dimension of punched sheet	± 0.5 mm.	- Vernier standard ruler
Layout	-	- Lay out the sheets for bending	Sampling MIL 105-E	- Dent line's dimension	± 1 mm.	- Meter tape - Standard meter
Bending	Bending machine	- Bend the sheets	Sampling MIL 105-E	- Bending dimension	± 1 mm.	- Meter tape
				- Bending angle		- Angle Indicator - Standard rule - vernier
Assembly	Spot Welding m/c Tig Welding m/c Hand Grinding Drilling m/c Drilling m/c	- Assy the sheet together	100%	- Welding surface	No contaminator, No undercut, over cut	- Measure tape - Standard ruler
				- Distortion	± 3 mm.	
				- Scratch surface	No scratch	
				- dimension	± 3 mm.	
Polishing	-	- Grinding and cleaning	100%	- Finished surface	Hairline polishing	-
Technical equipment Assy.	Lathe Tapping m/c Drilling m/c Electrical Welding	- Put the electronic part such as heater, switch	100%	- Part checking	Complete the job requirement	- Multi meter - Thermocouple
				- Part position	± 5 mm	- Measure tape
				- Welding surface	No contaminator, No undercut, over cut	- Standard ruler - Vernier
			Sampling			
			1 unit per lot (10 unit)	- Exterior temp.	< 65.5 celcius	
	- Product temp	< 58.7 celcius				

5.5 QUALITY ENGINEERING DEPARTMENT ESTABLISHMENT

One of several steps in developing control system is setting up a group of persons, who directly action on all quality issues. Especially, these peoples are independently about making decision on the inspection.

The department was designed based on their activities and working load. The department composed of 1 Manager, 1 Quality Assurance supervisor and 1 Foreman of quality control section as well as 3 Operators for Front line operation, Assembly and Technical assembly inspectors. Each of them has a job-description as follows.

5.5.1 Quality Engineering Manager

This position has directly responded to manage the department to achieve the quality policy and objective. The following is shown the job description and Job specification of this position.

5.5.1.1 Job description

This position has fully accounted to:

- 1) Provide a policy and objective of quality in the company
- 2) Set up quality indicator in the company with an agreement of top management
- 3) Manage training and transfer knowledge and skills to ensure that all employees understand and achieve the quality policy and its target
- 4) Coordinate with customers to ensure the products meet customer requirements
- 5) Coordinate with the accounting department to set up a quality cost establishment as well as making a report
- 6) Follow up the quality indicator in the company
- 7) Manage all subordinates to achieve quality policy and objective as planned quality
- 8) Prepare a report to top management by monthly

5.5.1.2 Job Specification

The following shows the qualification of the position

- 1) Bachelor degree or higher in Industrial Engineering, Mechanical Engineering, Engineering Management or related fields
- 2) At least 5 Years working experience in a manufacturing process of Stainless steel fabrication or Industrial fields preferably with a multi-national company. Especially, quality assurance is an importance
- 3) Familiarity with ISO 9001 and SOP
- 4) Well rounded and integrity with strong organizational and people management skill and analytical ability
- 5) Fluent in both written and spoken English
- 6) Computer literate

5.5.2 Quality Engineering Supervisor

This position was purposed for taking care all quality inspectors both quality assurance and control section including up dating and asking for advice from manager. The quality assurance supervisor has job descriptions and specifications himself as follows.

5.5.2.1 Job description

This position is entirely responsible to:

- 1) Formulate a quality planning and quality control
- 2) Coordinate with production supervisor, production planning and store to ensure the products are inspected
- 3) Provide a guideline of improving quality in manufacturing process to both production department and quality inspectors
- 4) Follow up the quality indicators and policy
- 5) Provide a variety of quality reports to manager
- 6) Provide an improvement plan for the manufacturing process

5.5.2.2 Job Specification

This position has several qualifications as follows.

- 1) Bachelor degree in Industrial Engineering, Mechanical Engineering, Engineering Management or related fields
- 2) Minimum 3 Years working experience in a manufacturing process of stainless steel fabrication or any industrial fields. Quality assurance experiences will be an advantage
- 3) Familiar with factory environment
- 4) Strong organizational skill, and proactive
- 5) Able to work independently and highly motivated
- 6) Computer literate

5.5.3 Quality Control Foreman

This position purposes to control and manage 3 quality inspectors. The following is job description and job specification.

5.5.3.1 Job description

This position is responsible to:

- 1) Coordinate with production supervisor, production planning and store to ensure the quality planning and control met the target
- 2) Improving quality under the supervisor's plan
- 3) Making decision on quality issues in the process and advise to supervisor
- 4) Follow up the quality indicators and policy
- 5) Audit the data and quality report from inspectors
- 6) Training inspectors and production operators to meet the quality target

5.5.3.2 Job Specification

This position has various requirements as follows

- 1) Male, age between 25 – 28 years old
- 2) Certificate in industrial management and mechanical
- 3) At least 2 years experience in fabrication manufacturing process or any industrial fields. Quality control experiences will be an advantage
- 4) Pleasant personality with good self-responsibility and proactively
- 5) Management skills and knowledge
- 6) Good command of English
- 7) Knowledge of computer

5.5.4 Quality Control Inspectors

The following is job description and job specification.

5.5.4.1 Job description

This position is responsible to:

- 1) Coordinate with production supervisor to inspect part and product to meet the quality specification
- 2) Improving quality under the supervisor's plan by using an advice of quality control foreman
- 3) Follow up the quality indicators and policy
- 4) Training inspectors and production operators to meet the quality target

5.5.4.2 Job Specification

This position has several requirements as follows

- 1) Male, age between 22 – 25 years old
- 2) Minimum 1 year working experience in a manufacturing process.
- 3) Excellent interpersonal and communication skills
- 4) Understand the quality concepts
- 5) Computer knowledge: Ms office

5.6 NEW ORGANIZATION DEVELOPMENT

According to, quality department was settled up as a result the organization would be re-organized as illustrated in figure 5.7.

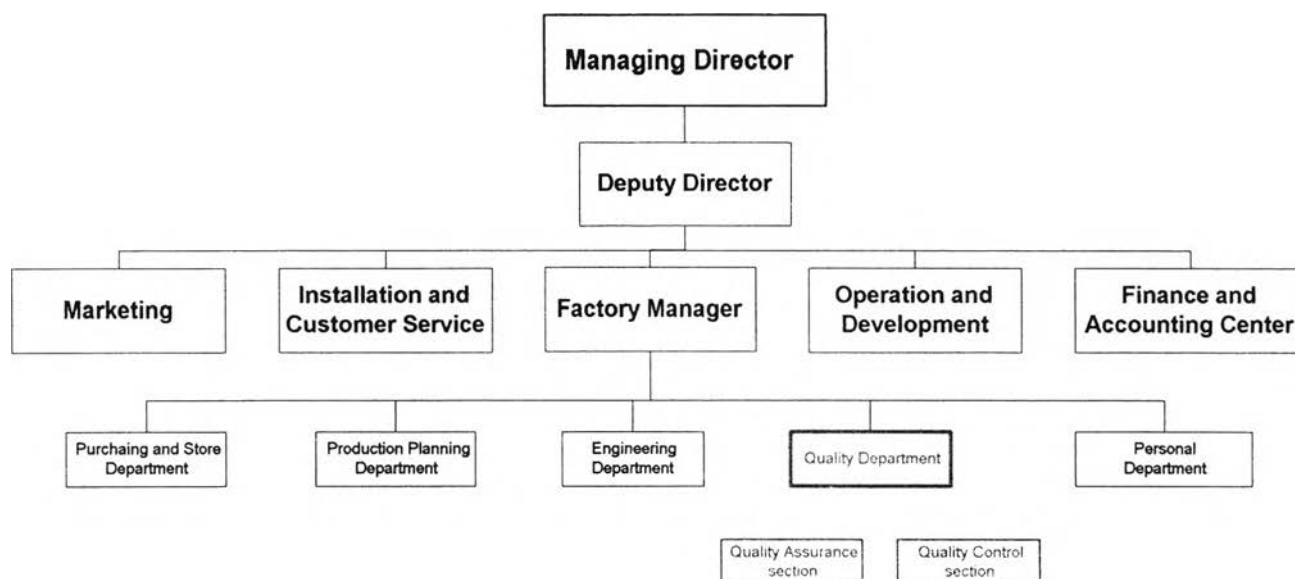

Figure 5.7: New organization

The figure 5.7 is showed that the quality department is composed of 2 section, Quality assurance and quality control managed by 1 manager. As mention earlier, 1 quality-engineering supervisor is positioned to take care both quality assurance and quality control section, while the 1 foreman and 3 operators taking care the quality control section. The following figure shows the quality organization.

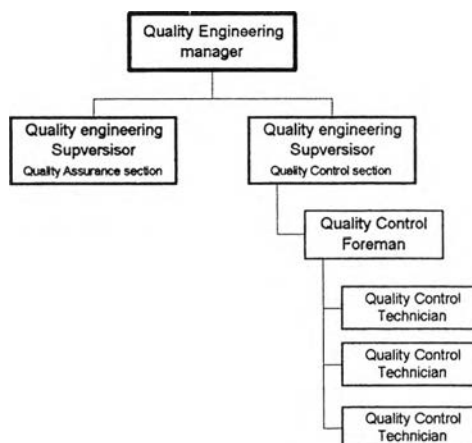

Figure 5.8: Quality organization

5.7 DOCUMENTATION AND INFORMATION FLOW

The documentation, which was used in manufacturing process, could be determined in 2 types: Quality inspection form and Quality inspection report. These forms were used to verify the defects, which were occurring in the process through 7 areas of inspection. In this paper, some of them were shown in Appendix III.

In addition, the following shows the process of quality in manufacturing process and people whom responses to the activity.











			PROCESS INSTRUCTION IN PROCESS INSPECTION					CODE : PM-QA-01 V01	
Provider (QC Supervisor)	Auditor (QC Manager)	Approval (Factory Manager)	SYMBOL						Page 1 of 1
			 Start/End	 Process	 Decision	 Connector	 Communication		
	PROCESS	QC Manager	QC Supervisor	QC inspector	Production Supervisor				Reference documents
1.1	Receive production plan								Production plans
1.2	Prepare the inspeciton plan								Sampling guide manual
1.3	Process inspeciton								processspecific ation and Inspection form
1.4	Ask for the production supervisor for corrective action								Corrective action request
1.5	Prepare report to QC manager in every week								QC report

Figure 5.9: In process inspection

From figure 5.9, quality control manager receive the production planning form production planning department, then pass the plan to quality control supervisor for planning the inspection. Next, the supervisor assigns the job to skill operator, which the inspection plan is informed to the inspector for inspection.

After that, inspector inspects the products and ships the inspected parts/products to further operation.

5.8 CORRECTIVE ACTION

The corrective action is a considered process, which were designed to control and find out the solution to solve the problems. The process of corrective action could be illustrated in figure 5.10.

			PROCESS INSTRUCTION CORRECTIVE ACTION					CODE: PM-QA-02 V01		
Provider (QC Supervisor)	Auditor (QC Manager)	Approval by (Factory manger)	SYMBOL							Page 1 / 1
			Start/End	Process	Decision	Connector	Communication			
	PROCESS	QC Supervisor	QC Inspector	Production Supervisor	Production Manager	Production planning			Reference documents	
1.1	Inspect the product in manufacturing process								Inspection form and DCF	
1.2	Found the error and inform production supervisor								Inspection form and DCF	
1.3	Prodction supervisor advise production manager to decide whether repair ornot.								Inspection form and DCF	
1.4	Production planning again								Corrective action request and plan	
1.5	Rework part was taken to production supervisor to negociie								DCF	
17	Rework part was taken to production supervisor to negociie								Inspection form and DCF	

Figure 5.10: Corrective action

5.9 QUALITY INVESTMENTS

The investment on quality system could be grouped into 2 types of investments that are fixed asset and working capital. By theory, both of them are so grouped in financial report as use of funds. The concepts is whatsoever money spent to provide tools to do the job (the fixed asset) and to provide materials, people and related services to support sale such as stocks and costs of good sold)

In term of quality control system, which was discussed in process specification and process. The fixed asset and working capital could be addressed below.

5.9.1 Fixed asset

The fixed asset for quality control system in manufacturing process is initially composed of:

	Unit	Cost	
1) Meter tape	3	650	Baht
2) Perpendicular meter	3	2570	Baht
3) Vernier	3	7500	Baht
4) Standard ruler	3	4500	Baht
5) Multi meter	2	18500	Baht
6) Thermocouple	5	5605	Baht
7) Computer	1	45000	Baht

These tools and equipment were used to assess the part and product quality for further eliminating of quality problems. In addition, the book value of these fixed assets is 10 years, so the depreciation per year is counted as the present value divided by 10, except computer is 5 years. As a result the depreciation a year was around 12932.5 Baht in initial 5 year, and 3932.5 Baht in the later 5 year.

5.9.2 Working capital

Even though, the quality system investment did not directly concern to the raw materials and stocks as manufacturing process did, they had some expenses on overhead concerns as shown below.

	Unit	Cost	
1) Wages	5	720000	Baht/year
2) Inspection tools calibration	19	120000	Baht/year
3) Other expenses		20000	Baht/year

Notes: the other expenses were such as water supply, telephone, paper, electric usages and etc.

The wages were calculated from the number of quality employees such as 1 Manager, 1 Supervisor and 3 Inspectors, whereas the tool and equipment would be calibrated in each year, except the first operating year.

5.9.3 Investment planning

According to, both working capital and fixed asset were a part of use of funds, as a result the budget planning is very important. The cost that had to pay yearly was shown in table 5.2.

Table 5.2: Investment plan

	<i>Year 1</i>	<i>Year 2</i>	<i>Year 3</i>	<i>Year 4</i>	<i>Year 5</i>
Fixed asset	84325				
Working capital	74000	192000	192000	192000	192000
Net asset employed	158325	192000	192000	192000	192000

From table 5.3, the cost of initial year were composed of both Fixed cost and Working capital, while the later year was only working capital because of either no tooling or equipment investment. Besides, the working capital in year 2 through 5 is greater than the first year, since the calibration cost, which is every year assessment.