

การใช้แนวคิดอาร์วีเอสไอเพื่อประเมินการคงตัวสีในภาพถ่าย

นางสาวจันทร์ประภา พ่วงสุวรรณ

วิทยานิพนธ์นี้เป็นส่วนหนึ่งของการศึกษาตามหลักสูตรปริญญาวิทยาศาสตรดุษฎีบัณฑิต
สาขาวิชาเทคโนโลยีทางภาพ ภาควิชาวิทยาศาสตร์ทางภาพถ่ายและเทคโนโลยีทางการพิมพ์
คณะวิทยาศาสตร์ จุฬาลงกรณ์มหาวิทยาลัย

ปีการศึกษา 2555

ลิขสิทธิ์ของจุฬาลงกรณ์มหาวิทยาลัย

บทคัดย่อและแฟ้มข้อมูลฉบับเต็มของวิทยานิพนธ์ตั้งแต่ปีการศึกษา 2554 ที่ให้บริการในคลังปัญญาจุฬาฯ (CUIR)

เป็นแฟ้มข้อมูลของนิสิตเจ้าของวิทยานิพนธ์ที่ส่งผ่านทางบัณฑิตวิทยาลัย

The abstract and full text of theses from the academic year 2011 in Chulalongkorn University Intellectual Repository (CUIR)

are the thesis authors' files submitted through the Graduate School.

UTILIZATION OF RVSI CONCEPT TO EVALUATE THE COLOR CONSTANCY
IN PHOTOGRAPHIC IMAGES

Miss Chanprapha Phuangsuan

A Dissertation Submitted in Partial Fulfillment of the Requirements
for the Degree of Doctor of Philosophy Program in Imaging Technology
Department of Imaging and Printing Technology
Faculty of Science
Chulalongkorn University
Academic Year 2012
Copyright of Chulalongkorn University

Thesis Title	UTILIZATION OF RVSI CONCEPT TO EVALUATE THE COLOR CONSTACY IN PHOTOGRAPHIC IMAGES
By	Miss Chanprapha Phuangsuan
Field of Study	Imaging Technology
Thesis Advisor	Assistant Professor Phichayada katemake, Ph.D.
Thesis Co-advisor	Professor Mitsuo Ikeda, Ph.D.

Accepted by the Faculty of Science, Chulalongkorn University in Partial
Fulfillment of the Requirements for the Doctoral Degree

..... Dean of the Faculty of Science
(Professor Supot Hannongbua, Dr. rer. nat.)

THESIS COMMITTEE

..... Chairman
(Associate Professor Aran Hansuebsai, Ph.D.)

..... Thesis Advisor
(Assistant Professor Pichayada Katemake, Ph.D.)

..... Thesis Co-advisor
(Professor Mitsuo Ikeda, Ph.D.)

..... Examiner
(Assistant Professor Chawan Koopipat, Ph.D.)

..... Examiner
(Associate Professor Pontawee Pungrassamee, M.S.)

..... External Examiner
(Kitirochna Rattanakasamsuk, Ph.D.)

จันทร์ประภา พวงสุวรรณ : การใช้แนวคิดอาร์วีเอสไอเพื่อประเมินการคงตัวสีในภาพถ่าย
(UTILIZATION OF RVSI CONCEPT TO EVALUATE THE COLOR
CONSTANCY IN PHOTOGRAPHIC IMAGES) อ.ที่ปรึกษาวิทยานิพนธ์หลัก : ผศ. ดร.
พิชญดา เกตุเมฆ, อ. ที่ปรึกษาวิทยานิพนธ์ร่วม : Prof. Mitsuo Ikeda, 80 หน้า

งานวิจัยนี้มีจุดมุ่งหมายเพื่อใช้แนวคิดอาร์วีเอสไอมาประเมินการคงตัวสีในภาพถ่าย เป็นที่ทราบกันดีในกลุ่มนักวิทยาศาสตร์ทางการมองเห็นว่าการเห็นสีสิ่งที่ไม่เกิดขึ้นเวลาที่เรามองภาพถ่าย เนื่องจากการมองเห็นของคนเราจะเป็นการรับรู้ในลักษณะสามมิติ และภาพถ่ายคือวัตถุชิ้นหนึ่งในสภาพแวดล้อมที่เป็นสามมิติ ฉะนั้นการเห็นสีสิ่งในภาพถ่ายจึงไม่เกิดขึ้น ทฤษฎีอาร์วีเอสไอ ได้อธิบายการมองเห็นสีของมนุษย์ด้วยทฤษฎีดังกล่าว รวมถึงอธิบายการเห็นสีที่ภายใต้แหล่งกำเนิดแสงสีต่าง ๆ ทฤษฎีอาร์วีเอสไอ กล่าวว่าไว้ว่า เวลาเราเข้ามาในห้อง ๆ หนึ่ง เราจะรับรู้ถึงพื้นที่ในห้องนั้น และเข้าใจว่าห้องนั้นส่องสว่างด้วยแสงอะไร จากนั้นเราจะปรับการมองเห็นเข้ากับสภาวะแสงนั้น เมื่อเราปรับการมองเห็นแล้ว เราจะสามารถรับรู้สีของวัตถุจริง ๆ ได้ งานวิจัยนี้ได้นำหลักการดังกล่าวมาประยุกต์กับการมองเห็นสีในภาพถ่าย ด้วยการตัดข้อมูล และสิ่งแวดล้อมภายนอกภาพถ่ายออก ทำให้เรามองเห็นแต่ภาพถ่าย ซึ่งสัญญาณภาพดังกล่าวจะมีลักษณะสองมิติที่เรตินา และเมื่อสมองเราแปรผล ก็จะแปรผลกลับมาในลักษณะสามมิติทำให้เรารับรู้ว่าภาพนั้นมีลักษณะสามมิติ รับรู้ถึงพื้นที่ และเข้าใจถึงแสงที่ส่องสว่าง จากนั้นเราก็จะปรับสภาพเข้ากับแสงในภาพถ่ายนั้น ทำให้เราเกิดการเห็นสีสิ่งที่ได้ในภาพถ่าย ซึ่งในงานวิจัยนี้ ได้ใช้อุปกรณ์ที่ใช้ช่วยในการมองภาพให้เป็นสามมิติ จำแนกได้เป็นวิธีแบบ ดาเดียวซึ่งใช้ในการทดลองแบบ D-up และสองตาซึ่งใช้ในการทดลองแบบสเตอริโอสโคป

ในงานวิจัยครั้งนี้ ได้ตั้งสมมุติฐานว่า การเห็นสีสิ่งที่ในภาพถ่ายจะเกิดขึ้นเมื่อผู้สังเกตเลือกภาพที่มีค่าสีทางฟิสิกส์ใกล้เคียงกับค่าสีทางฟิสิกส์ในห้องทดลองที่เรากำหนดไว้ ซึ่งผลการวิจัยสามารถจำลองให้เห็นได้ว่าการเห็นสีสิ่งที่ในภาพถ่ายสามารถเกิดขึ้นได้

ภาควิชา วิทยาศาสตร์ทางภาพถ่าย	ลายมือชื่อนิติติ.....
และเทคโนโลยีทางการพิมพ์	ลายมือชื่อ อ.ที่ปรึกษาวิทยานิพนธ์หลัก.....
สาขาวิชา เทคโนโลยีทางภาพ	ลายมือชื่อ อ. ที่ปรึกษาวิทยานิพนธ์ร่วม.....

ปีการศึกษา 2555

5273805523 : MAJOR IMAGING TECHNOLOGY

KEYWORDS : COLOR CONSTANCY / ILLUMINATION / RVSI THEORY / PHOTOGRAPH / COLOR APPEARANCE

CHANPRAPHA PHUANGSUWAN: UTILIZATION OF RVSI CONCEPT TO EVALUATE THE COLOR CONSTANCY IN PHOTOGRAPHIC IMAGES.

ADVISOR: ASST. PROF. PICHAYADA KATEMAKE, Ph.D., CO-

ADVISOR: PROF. MITSUO IKEDA, Ph.D., 80 pp.

The color constancy is an important property of the human visual system to recognize objects properly. It was said that the color constancy did not take place in photographic images, but the recognized visual space of illumination RVSI theory predicted the color constancy to take place in photographic images if the images could be perceived as three dimensional scenes. A D-up viewer was constructed with which a photograph can be perceived as a 3D scene in the first experiment and it was shown that the color constancy in the photograph took place as for the real space. The matching technique of color impression of a real room and that of a photographic image was successively used to achieve the experiment. While one eye was used in the D-up viewer, two eyes were used in the second experiment where a stereoscope was employed. It was proved that the color constancy also took place in photographic images. In the third experiment the state of color adaptation of subjects was investigated by measuring the color appearance of an achromatic stimulus patch inserted in a photograph. The color appeared very vivid in spite of the fact that the stimulus was achromatic when the photographs were prepared under vivid orange or blue illumination. The color adaptation of the visual system in photographic images was confirmed. General discussion was made for three experimental results and it was concluded that the color constancy could take place in photographic images.

Department : Imaging and Printing Technology Student's Signature

Field of Study : Imaging Technology Advisor's Signature

Academic Year : 2012 Co-advisor's Signature

ACKNOWLEDGEMENTS

I like to acknowledge my supervisor, Assistant Professor Pichayada Katemake at the Department of Imaging and Printing Technology, Chulalongkorn University, and the co-supervisor Professor Mitsuo Ikeda, a distinguished professor at Chulalongkorn University, who supervised me patiently and properly during my studentship at Chulalongkorn University. I would thank Assistant Professor Chawan Kupipatana, Associate Professor Aran Hansebsei, Associate Professor Pontawee Pungrassamee at Chulalongkorn University and Dr. Kitirochna Rattanakasamsuk, a lecturer at Rajamangala University of Technology Thanyaburi, who gave me valuable comments as committee members of my Ph.D. defending.

I shall mention my special thanks to Professor Mitsuo Ikeda and his wife Dr. Fusako Ikeda in Japan, who accepted me and let me stay at their house for almost two months when I needed Professor Ikeda's advice for my research as well as for my thesis for several times. I would like to give my sincere thanks to Professor Hiroyuki Shinoda at Ritsumeikan University, Japan, who accepted me as a visiting researcher for nine months and helped me in my research. I like to thank Professor Shinoda's laboratory members also. My thanks should go to Dr. Tomoko Obama who continuously encouraged me throughout my student life.

I would like to thank Dr. Vichai Payackaso, Dean of Faculty of Mass Communication Technology, Rajamangala University of Technology Thanyaburi, who gave me the opportunity to study for Ph.D. at Chulalongkorn University with a scholarship that supported me both at Chulalongkorn University and at Ritsumeikan University.

Many thanks to laboratory members at Chulalongkorn University including those who already graduated.

Finally, I would like to thank my parents and my sister who supported me for many years by continuously encouraging with deep love.

CONTENTS

	Page
ABSTRACT IN THAI	iv
ABSTRACT IN ENGLISH	v
ACKNOWLEDGEMENTS	vi
CONTENTS	vii
LIST OF TABLES	ix
LIST OF FIGURES	xii
CHAPTER I INTRODUCTION	1
1.1 Background and rationale	1
1.2 Objectives	4
1.3 Outline of research	4
CHAPTER II LITERATURE REVIEW	6
2.1 RVSI Theory	6
2.2 Review of the past papers	8
CHAPTER III EXPERIMENT I	12
Color constancy in photographs with D-up viewer	
3.1 Introduction	12
3.2 Apparatus	12
3.2.1 D-up viewer	12
3.2.2 Experimental room	13
3.2.3 Apparatus to confirm 3D perception	16
3.3 Procedure	18
3.3.1 Confirmation of 3D perception	18
3.3.2 Procedure for color constancy experiment	19
3.4 Result	20
3.4.1 3D confirmation	20
3.4.2 Results of color constancy	21
3.5 Discussion	27
CHAPTER IV EXPERIMENT II	30
Color constancy in photographs with stereoscope	
4.1 Introduction	30
4.2 Apparatus	30
4.2.1 Stereoscope	30
4.2.2 Experimental room	31
4.3 Procedure	35
4.4 Result	36
4.5 Discussion	41
CHAPTER V EXPERIMENT III	42
Color appearance of an achromatic patch on photographs viewed with D-up viewer	

	Page
5.1 Introduction.....	42
5.2 Apparatus and experimental condition.....	43
5.3 Preparation of picture stimuli.....	45
5.4 Experimental condition and procedure.....	47
5.5 Supplemental experiment.....	50
5.6 Result of experiment III.....	51
5.7 Discussion on experiment III.....	63
CHAPTER VI GENERAL DISCUSSION.....	66
6.1 General discussion on three experiments.....	66
6.2 Conclusion.....	69
6.3 Suggestion for future research.....	70
REFERENCES.....	71
APPENDIX.....	74
BIOGRAPHY.....	80

LIST OF TABLES

Table	Page
5-1 Luminance ratio between the wall and the stimulus patches in photographs.....	47
5-2 The illuminance (lx) of the test room for combinations of stimulus patch and... illumination of the subject room	48

LIST OF FIGURES

Figure	Page
2-1 A slow chart to explain the construction of RVSI.....	6
2-2 Explanation of RVSI.....	7
3-1 Scheme of D-up viewer.....	13
3-2 Experimental room and D-up viewer (D).....	14
3-3 Spectral transmittance of blue and orange films.....	14
3-4 Chromaticity coordinates of illuminations and picture stimuli.....	15
3-5 Examples of picture stimuli, Pb13 on the left and Po13 on the right.....	16
3-6 Picture stimuli used in the experiment.....	17
3-7 Apparatus to confirm 3D perception.....	18
3-8 Mosaic stimulus for a control experiment.....	18
3-9 Results of perceived angles of V-shaped frames.....	20
3-10 Examples of datasheet.....	21
3-11 Probability-of-seeing curves of redder response for two illuminations.....	22
3-12 Probability-of-seeing curves of redder response plotted for five subjects....	23
3-13 Probability-of-seeing curves of bluer response plotted for five subjects.....	24
3-14 Averaged probability-of-seeing curves plotted for x values.....	25
3-15 Probability-of-seeing curves plotted for distance from a white point.....	26
3-16 Picture colors vs illumination colors plotted for normal view	27
3-17 Illustrations to explain the experimental results by RVSI.....	28
3-18 Picture colors vs illumination colors plotted for normal view	29
4-1 Schematic view of stereoscope; left, top view and right, front view.....	30
4-2 Experimental room.....	31
4-3 Front view in the experimental room.....	32
4-4 Chromaticity coordinates of illuminations and picture stimuli.....	33
4-5 A pair of picture stimuli (top) and the arrangement of a camera (bottom).....	33
4-6 Twenty two picture stimuli used in the experiment.....	34
4-7 Apparatus to show the experimental procedure.....	36
4-8 Probability-of-seeing curves of redder response plotted for five subjects.....	37
4-9 Probability-of-seeing curves of bluer response plotted for five subjects.....	38
4-10 Averaged probability-of-seeing curves plotted for x values.....	39
4-11 Probability-of-seeing curves plotted for distance from a white point.....	40
4-12 Picture colors vs illumination colors plotted for normal view	40
4-13 Picture colors vs illumination colors plotted for normal view	41
5-1 Explanation of color appearance by RVSI.....	42
5-2 Schematic view of the experimental room.....	43
5-3 A picture of the experimental room.....	44
5-4 D-up viewer.....	45
5-5 Arrangement for the normal viewing experiment.....	45
5-6 Chromaticities of illumination (circles) and of photographs (x).....	46

	Page
5-7 Photographs used in the D-up and the normal view	47
5-8 A subject using the D-up viewer.....	49
5-9 A subject doing the normal view experiment.....	50
5-10 A mosaic picture PM4. T denotes the stimulus patch	51
5-11 Amounts of elements in percentage plotted for illumination L.....	52
5-12 Hue appearance change shown by a polar diagram.....	52
5-13 Percentage of amounts of elements.....	53
5-14 Amounts of chromaticness for three experiments.....	54
5-15 Percentage of elements for illumination.....	56
5-16 Averaged percentages of the amounts of elements of five subjects	59
5-17 Averaged amounts of elements from five subjects.....	60
5-18 Hue appearance change for illumination of five subjects	61
5-19 Averaged amounts of elements of N3 for illumination	62
5-20 Amounts of whiteness of N3 for illumination.....	63
5-21 Averaged elements.....	63
5-22 Illustration to explain the result by RVSI.....	64
6-1 Color of picture stimuli chosen for illumination color of the real room.....	67
6-2 Comparison of visual field of a subject	68

CHAPTER I

INTRODUCTION

1.1 Background and rationale

Illumination in our environment changes from time to time and from place to place. For example when we enter into a building from outdoors, the illumination changes from the daylight to incandescent light. The incandescent light is reddish compared to the white daylight. If we look at a white object under the incandescent lamp the light that comes to our eyes changes from white to red, but our perception for the white object does not change. That is, the white object appears white whether in the outdoors or in the building. This consistency of the apparent color of objects is called the color constancy. Ikeda and colleagues [1-4] introduced the concept of the recognized visual space of illumination (RVSI) to explain the color appearance of objects and lights. When a person looks at, comes into, or stays in a space they understand the illumination in the space and adapt to the brightness and color of the illumination. The concept asserts two points; the recognition of a space and the adaptation to the illumination in the space. It is natural for a person to recognize a three dimensional (3D) space in whatever they see since they always live in a visual 3D space and so must always visually perceive a 3D space. When the person recognizes a space they understand the illumination filling in the space. The adaptation is neither to the light coming from the objects nor to the color of the objects but to the illumination filling the entire space including the empty spaces. In other words, it is the adaptation within the brain (“適応 teki-oh” in Japanese or the higher stage adaptation) as the adaptation takes place only when a person recognizes the existence of the space [5-9]. The adaptation is a positive action and not a form of retinal adaptation (“順応 jun-noh” in Japanese or the lower stage adaptation or the peripheral level adaptation), which is a passive action. The adapted brain state is expressed as the brain constructed a RVSI for the space. The apparent lightness and apparent color of anything in the space are then determined based on the RVSI. The concept asserts that a RVSI is always constructed in a person whatever they see and the color perception is gained accordingly. It must be pointed out that two dimensional (2D) RVSI does not exist. In this respect the words 2D and 3D must be used with care. 2D perception exists in a RVSI but it is a 2D plane perception in a 3D space perception. A 2D stimulus can be used [9, 10], but the stimulus may be perceived as a 2D object in a 3D space perception that is constructed by the entire surrounding including the stimulus. It should be pointed out that the RVSI concept

does not discuss a mechanism as to how a person understands the illumination but starts from a point they understand by any means, although the concept defines objects and other cues in the space that they first see as the initial visual information and the RVSI becomes more complete with as more initial visual information is acquired [2, 3, 12].

The RVSI concept was applied to some apparent lightness phenomena [13], such as the White effect [14], the simultaneous contrast demonstrated by Heinemann [15], the Kofka ring, the Kanisza pattern and the Gilchrist experiment [16], so as to show the importance of space recognition. Most of these researchers used 2D patterns as a stimulus, except for Gilchrist [16], but the patterns were interpreted to produce RVSI to some extent to explain their results successfully. A new stimulus pattern that consisted of gratings was then introduced to strengthen the idea of RVSI [13].

The importance of space recognition was also shown for the color constancy. Pungrassamee et al. [8, 9] employed a two rooms technique, where a subject stayed in one room illuminated by color light and observed, through a window opened between the two rooms, the stimulus placed in another room that was illuminated by a daylight type lamp. When the subject room was illuminated with a red ceiling light and the stimulus was achromatic, and when the window was small so that only the stimulus was seen to the subject, the stimulus appeared as a vivid bluish green patch pasted on the window. When the window was enlarged the stimulus returned to its original achromatic color indicating color constancy was obtained. Color constancy took place immediately when only a small part of the room around the stimulus was seen, that is, the color constancy took place when the subject recognized the existence of the stimulus room. Space recognition is the obligatory factor for the color constancy. Many researchers have investigated color constancy by various approaches, but it seems important to employ a real room or real objects in carrying out the experiment, as has been done by some researchers [10-12, 17-22].

It is a common understanding that color constancy does not hold in a photographic picture. A picture taken under an incandescent lamp appears very orange when the picture is observed under a white lamp. A white object in the picture is no longer white but pale orange. The RVSI concept can explain this fact and suggest a way to demonstrate the color constancy in a photographic picture. The reason for the failure of the color constancy in a picture lies in the failure of perceiving a 3D space in the picture. If, therefore, we can perceive a 3D space in a photographic picture the color constancy should take place according to the RVSI concept. The question then is how can the viewer do this? Any retinal image of the outside scene is a 2D image, yet

we appear to perceive it as a 3D scene. This fact indicates that our brain changes the 2D image to a 3D scene. That is, our brain has a dimension-up (D-up) function. When we see a photographic picture placed in a room we see a mere 2D picture because the D-up function of the brain is already used for the 3D room. If, however, we input only the picture to the eye such that the retinal image contains only the image of the picture and nothing else, then the D-up function of the brain should be used for the retinal image of the picture and we should perceive a 3D scene for the picture. The color constancy is expected to take place for the picture. Mizokami et al. [21] employed this logic and did an experiment to obtain an achromatic perception for a small test patch in a photographic picture observed with a dimension-up viewing box. Two pictures were investigated, which were taken under the daylight type and the incandescent type fluorescent lamp, respectively. The results showed good color constancy with some subjects but poor or no color constancy with other subjects. We suppose that a large variance among subjects and the failure to obtain the color constancy with some subjects were because of the difficult task of the subject to judge absolutely the achromaticness on a small test patch without reference. In the present research we employ the same logic of 3D perception of a photographic picture as Mizokami et al. but different experimental method. The subjects compare colors of a real room illuminated by a colored light and of photographic pictures taken under various colors, and choose a photographic picture that gives the same color impression as for the real room. This is a kind of matching experiment and should be easier for the subjects in their judgment. We will cover wider color range of the room illumination than Mizokami et al. to know systematically the effect of the room color for the color constancy.

In the first experiment of the present research we employ the above mentioned principle to create a 3D scene for a 2D photograph. That is, we present only the photograph to one eye without presenting any other scene. To realize this experiment we build a D-up viewer.

In the second experiment we use a technique of a stereoscope to create a 3D scene. In this case two photographs are presented to two eyes, respectively by using the stereoscope. In the first experiment we use only one eye of the subjects but in the second experiment we use both eyes of the subjects. The effect of using one eye and two eyes can be investigated.

We do the third experiment similar to Mizokami et al. but with different criterion for judgment of color. As explained before Mizokami et al. asked subjects to obtain a patch that appeared achromatic or neutral in color. In the present experiment

we ask subjects to judge the color of a stimulus patch and report the color by the elementary color naming method. While Mizokami et al.'s method is a kind of the null method ours is a kind of the absolute judgment of color appearance.

1.2 Objectives

We set two objectives for the present research and carried out three experiments, Experiment I, Experiment II, and Experiment III.

Objective 1; To develop a new method to prove the color constancy in the photographic images by using a D-up viewer technique (Experiment I) and by using a stereoscope technique (Experiment II).

Objective 2; To show the color constancy in the photographic images by measuring the color appearance of a patch placed in a photographic picture (Experiment III).

1.3 Outline of thesis

In Experiment I, the D-up viewer technique was used to create three dimensional perceptions in a photograph and showed the color constancy in the photograph. We built an experimental room with controllable color and illuminance of the illumination so that subjects could experience the color constancy in the room. The experimental room was consisted of two rooms, a subject room and a stimulus room, but only the subject room was used in Experiment I. The experiment was composed of two viewing conditions, D-up viewing and normal viewing. We built D-up viewer so that subjects could perceive a 3D scene in a photograph by looking at the photograph through a hood with one eye. For the normal viewing condition a simple arrangement was prepared so that subjects could observe a photograph under a normal viewing situation. Subjects saw the photograph just as they observe photographs in their daily life. In the experiment I many photographs were necessary that were taken under different illumination colors and they were prepared by a camera and the final photographs were printed at a photo-shop in Bangkok. Twenty six photographs were made. Five subjects, all from Chulalongkorn University participated in the experiments.

Experiment II was conducted while Chanprapha Phuangsuvan stayed at Ritsumeikan University in Japan as visiting researcher for nine months. A similar experimental room as in Experiment I was built and a stereoscopic apparatus was built to create 3D perception in two photographs. Similar photographs as in Experiment I were made but almost double in number, (44 photographs). In this case the photographs were printed by an ink-jet printer in the laboratory of Ritsumeikan

University. Five subjects, three Thai students at Ritsumeikan University, one Japanese student, and myself, participated in the experiment.

In Experiment III the color constancy in a photograph was approached by a method different from the dimension-up technique of Experiment I and II. It is to utilize the visual property of chromatic adaptation. In this experiment the stimulus room of the experimental room was also used where an achromatic stimulus patch was placed. Subjects observed the patch through a small window opened on the separating wall between the subject room and the stimulus room, and judged its color appearance by the elementary color naming method. The D-up viewer used in Experiment I was also used here in Experiment III. A simple arrangement to observe a photograph under a normal viewing situation was prepared so that subjects could observe the photograph in the laboratory illuminated by the ceiling lamp as well as the daylight coming from windows. Five subjects, all from Chulalongkorn University participated in the experiments. A supplementary experiment was conducted as a control experiment. Mosaic pictures were prepared from photographs used in Experiment I and III to unrealize 3D perception in the picture and the color appearance of a stimulus patch in the picture was investigated through the D-up viewer to see whether the achromatic stimulus patch remained achromatic. Three subjects, students at Chulalongkorn University participated in the supplementary experiment.

CHAPTER II LITERATURE REVIEW

2.1 RVSİ theory

Ikeda et al. [1-4] introduced a new concept named the recognized visual space of illumination (RVSİ) to explain the color appearance of objects and lights. The concept can be explained by a flow chart shown in Fig. 2-1. The concept emphasizes the recognition of a space to begin with. A person recognizes the existence of a space as the first step and then understands the illumination that fills the space such dim illumination, bright illumination, red illumination, or white illumination. He/she then adapts to the illumination himself/herself and constructs a RVSİ for the space. Finally the color appearance of objects in the space is determined by the RVSİ. The important point in the RVSİ theory is that the eyes adapt to the illumination and not to light

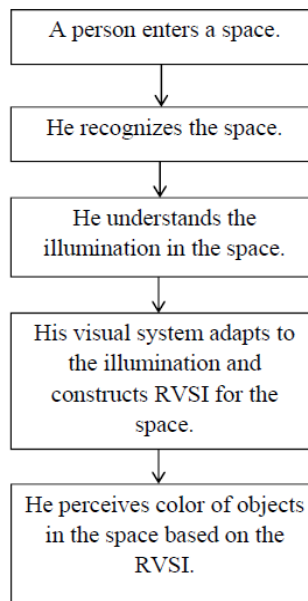

Fig. 2-1 A flow chart to explain the construction of RVSİ.

coming from a surface. Suppose a case that one looks at a large surface of red color placed in a room illuminated by a white light. His retina receives red light. Does his visual system adapt to the red light? The RVSİ theory says “No” but it says the visual system adapts to the white illumination because the room is illuminated by a white light. The RVSİ can be said the brain adaptation theory, and not the retinal adaptation theory.

The RVSI is illustrated by a sphere or for simplicity by a circle as shown in Fig. 2-2. On the left side a RVSI for a white illumination is shown. Axes will be drawn

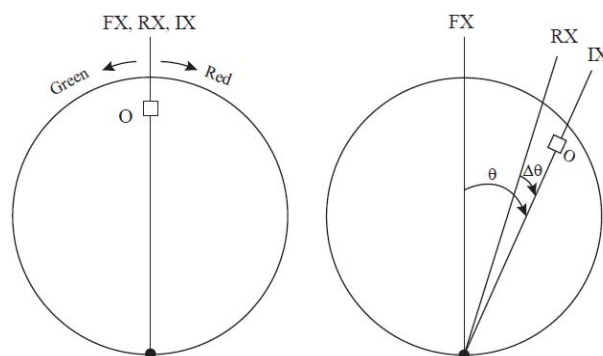

Fig. 2-2 Explanation of RVSI. Left, a case of white illumination, right, a case of red illumination.

from the bottom point shown by a black spot to indicate color. The axis FX goes straight up from the point to show the absolute achromatic color and it is called the fundamental axis. The clockwise direction corresponds to red and the anticlockwise direction to green. There are two other directions for yellow and blue but they can not be shown in this two dimensional illustration. When a room is illuminated by a white light such as the daylight type fluorescent lamp an axis IX is drawn vertically to coincide with FX and it is called the illumination axis. The axis RX is called the recognition axis and represents the achromatic perception under various situations. Any object O in this space is shown by a point in the circle and the open square shown in the figure gives an achromatic object. Let us suppose that the space is illuminated by a red light. Then the illumination axis is shown by an axis rotated to the red direction by an angle θ as seen in the right figure of Fig. 2-2. The physical color of the achromatic object O should be same as the illumination color and the object O is shown on IX in this case. When a person enters this space his visual system adapts to the illumination color IX and its perceptually achromatic axis RX is drawn near to IX having the residual angle $\Delta\theta$. The white object O appears a slightly red in this space and the residual angle $\Delta\theta$ should be small. The rotation of the recognition axis RX toward the illumination axis IX is nothing but the adaptation of the brain to the red illumination. The color appearance of any object is determined based on this RVSI and the color is determined by the angle to the object from RX. Ikeda et al. succeeded to explain many phenomena of the color appearance by applying the RVSI concept and some of them will be explained in the next section 2.2.

2.2 Review of the past papers

The subject of the color constancy has been taken up by many authors for many years and there exist many papers on the subject. Here only papers closely related to the present research will be reviewed.

By the development of computer display it became easier to present stimulus of various patterns and colors related to illumination on displays and many researchers started to use computer controlled displays for the study of the color constancy. A typical example is a research done by Arend and Reeves [23]. They presented two Mondrian patterns side by side, the left one simulating the illumination of 6500K and the right illumination of 4,000 or 10,000K. Subjects were asked to match the color appearance of a test patch placed at the center of the right pattern to the reference patch place at the center of the left pattern. Subjects set the color of the test pattern to the color of the reference patch as if both patches were made of a same paper, which showed the color constancy. It is our belief that the color constancy should be studied for real 3D space and we do not take the position of Arend and Reeves who used a 2D display. Recently other researchers started to pay attention to the 3D stimulus and there have been some researches along this line. Brainard et al. [17] built an experimental room of the size 263 cm wide and 340 cm long and illuminated the room by a computer control to different colors. Illumination of the left hand side and the right hand side of the room was made slightly differed. A gray test surface was placed on the left side of the front wall and another gray match surface was on the right side of the front wall. Subjects were asked to control the illumination for the match surface to make its color same as the test surface. If the color constancy holds the psychophysical color of the match surface should be same as the psychophysical color of the test surface when it is illuminated by the illumination for the match surface. They calculated the color constancy index and obtained around 0.6 from five subjects. If the color constancy is perfect the index should be 1.0. The use of the real room, they say, improved the color constancy. Brainard [18] continued to use the real experimental room as the research [17] but increased the surrounding information for the test surface by putting many colored patches. He hoped the increase of the information should improve the color constancy as the subjects can understand about the illumination more correctly and indeed he obtained about 0.9 of the color constancy index, very close to 1.0. In a new experiment by Kraft and Brainard [19] they built two chambers of the size 102 cm high, 70 cm wide, and 73 cm deep, respectively and placed a Macbeth Color Checker, varieties of objects, and a test

patch. Two chambers were illuminated by light of different color and subjects were asked to adjust the test patch until it appeared achromatic. The classic hypotheses; local adaptation, adaptation to spatial mean of image and adaptation to the most intense image region were investigated by using different color of the background and the chamber illumination. The result implied that the color appearance of the test patch mostly determined by the color of illumination but not the color of the surrounding of the test patch. We like to point out here that the experimental technique of the above researches reported by Brainard et al. was to adjust a test patch to a neutral color appearance.

De Almeida et al. [22] did not use an experimental room where subjects could stay in but employed a 3D stimulus. Small boxes like a cube and a tube were made by colored papers and they were put on steps made from colored paper. The left half of the steps was illuminated by a blue light of 25,000 K and the right half by different color ranging from 25,000 K to 4,000 K. One of the cubes on the right half was replaced by a black paper and it was filled by a cube seen via a beam splitter. The cube could be illuminated by any color and worked as the matching object of which color should be made equal to another cube placed on the left hand side. If the colorimetric color of the matching cube came close to the illumination color the color constancy was understood high. It was 0.81 to 0.93 and the authors concluded the 3D stimulus worked to increase the color constancy. No control experiment was done at this time where 2D stimulus was employed. The same authors, De Almeida et al. [10] employed in the next work a 3D stimulus same as the previous work [22] and a 2D stimulus which was made of only flat papers of various colors and obtained the color constancy index similarly as the previous work. The results showed, however, the color constancy index did not differ among the two stimuli, 3D or 2D. We like to point out that the difference among 3D and 2D stimuli was small because the subjects could see the background or surrounding of the stimulus in both cases. In other words the subjects could perceive 3D scene even for the 2D stimulus and both conditions were in fact a 3D condition. Stimuli of different dimension, 2D and 3D were also investigated by Xiao et al. [20]. They used a stereoscopic technique to create a 3D scene on two CRT monitors. The stimulus pattern was a kind of geometrical pattern consisting of spheres and squares with some shade and shadows. The subjects were asked to make the test object placed at the center of the stimulus achromatic in color under various illumination colors. The test object was a flat matte paper, a matte sphere, or a glossy sphere and they investigated whether the 3D sphere test object gave better color constancy than the 2D flat paper. The result was that there was no

difference to first order between the two, but there was found secondary difference when they analyzed the data in relation to the background condition, the consistent-cue condition and the reduced-cue condition.

The importance of the space recognition in the color constancy was shown by Pungrassamee et al. [8] by using two rooms technique. A test patch was placed in a test room of which illumination was white and was observed through a window opened on the separating wall between the test room and the subject room. The window size was variable. When the illumination in the subject room was red, for example, and the window was small so that a subject could see only inside of the test patch, the patch appeared to locate on the wall or as an object in the subject room and appeared greenish blue, the opposite color to the room illumination. When the window was opened large so that the subject could see objects in the test room surrounding the test patch the color appearance of the test patch returned to achromatic to indicate the color constancy. They clearly showed that the color constancy took place whenever the subject could recognize the existence of the test room. The result clearly showed that the space recognition was “must” for the color constancy. Ikeda et al. [9] used the same technique of the experiment and the same experimental room as Pungrassamee et al. but polarizing the color of objects to red or green. The color of the test patch was not influenced by these background colors when the color constancy took place. They concluded that the color constancy is the result of the brain activity and not the result of the retinal activity. They used the words the brain adaptation and the retinal adaptation.

Ikeda et al. [24] developed the two rooms technique which was employed by Pungrassamee et al. [8] and investigated the chromatic adaptation. The small window between the subject room and the test room was kept small so that the window was filled by the test patch placed in the test room. The color appearance of an achromatic test patch was judged by the elementary color naming method from the subject room where various colors of illumination were employed. The test patch appeared differently depending on the color of the illumination. When the illumination in the subject room was vivid red the test patch was very vivid greenish blue to show the chromatic adaptation of the visual system to the red illumination.

The color impression of photographs under various illumination colors was investigated by Ikeda et al. [25]. An experimental room of the size 150 cm wide, 400 cm long, and 210 cm high was built. The room was divided to a subject room and a test room and a window of the size 25.5 cm wide and 20.5 cm high was opened so that a subject could see a photograph placed in the test room illuminated by a white

light. Sixteen photographs of the subject room were prepared for the room illumination covering 3,000 K to 10,000 K. A subject first observed the subject room illuminated by room illumination color 2,900 K or 12,000 K and remembered the color impression of the room, which was the consequence of the color constancy. Then the room illumination was changed to one of three illumination colors 4,200 K, 6,000 K, and 12,000 K in the case of the observing color of 2,900 K and 6,000 K, 4,200 K, and 2,900 K in the case of the observing color of 12,000 K. The subject chose a photograph of which color impression was closest to the color impression for the room at the observing time. In fact the authors' aim of the research was to find color of photograph that gave the same color impression as the real scene so that the proper color modification could be done for photograph to give the same color impression for the real room in the photograph. But the technique to use photographs to match the color impression for the real room was used in the present experiment. Mizokami et al. [21] also employed photographs but their interest was on the color constancy in photographs. Two photographs of a living room in a normal house were prepared under the illumination 3,000 K and 6,000 K, respectively. Based on the RVSI theory they created a space in the photographs by the use of a dimension-up viewing box which limited the subject's visual view to the photograph only and investigated the color constancy in the photographs. At the center of the photographs a hole of the size $1.5 \times 2.3 \text{ cm}^2$ was opened and a color scale was placed behind the hole so that the subject could see one of the colors on the scale. The subject was asked to select a color patch that appeared achromatic. The experimental rationale was that if the color patch of the same colorimetric color as that of the illumination for the photograph was selected the color constancy was same as for the living room. Some subjects showed the expected result but others did not show any color constancy as for the living room.

CHAPTER III
EXPERIMENT I: COLOR CONSTANCY IN PHOTOGRAPHS
WITH D-UP VIEWER

3.1 Introduction

We hypothesized in chapter 1.1 Background and rationale based on the RVSI, that the color constancy should take place if we could perceive a three dimensional scene in a photograph. There are some techniques to realize this perception but the principle used by a Dutch artist, Samuel van Hoogstraten, was chosen, who developed a peep box in around 1655-60. In front of the box there was a small hole through which a person could peep inside, where a painted scene with a good perspective was placed. The person could see a 3D scene of the drawing. It is understandable if we consider how we see the outside world. The outside world is a 3D space but when it is projected on the retina it is no longer three dimensional but a mere two dimensional. Yet we perceive a 3D scene of the outside world. This indicates that the retinal 2D image is transferred to a 3D scene by brain. The brain has a function of the dimension up, 2D to 3D and whenever the brain receives a 2D image the brain automatically changes it to a 3D scene. So the information flows in the way that a 3D scene of the outside world to a 2D retinal image and to a 3D scene of the outside world in the brain. If a person sees a 2D photograph, its retinal image is also a 2D image. There is a chance that the 2D image is transferred to a 3D scene in the brain if the person sees a 2D photograph. Suppose a photograph is placed in a room and a person looks at it. Does he/she see a 3D scene in the photograph? The answer is No. He/she sees a mere 2D scene. It must be noted that the dimension-up function of the brain is used for the 3D room already and the 2D photograph remains a 2D scene. Therefore in the peep box a person looks inside the box by one eye through a small hole so that he/she can see only the drawing placed inside and no others beside the drawing. The principle of the peep box was employed to perceive a 3D scene for a 2D photograph in Experiment I and built a D-up viewer.

An experimental room was also built so that subjects could experience the color appearance for a real room.

3.2 Apparatus

3.2.1 D-up viewer

To perceive a 3D scene for a photograph a D-up viewer was built, of which scheme is shown in Fig. 3-1. The essential point of the apparatus is to present the

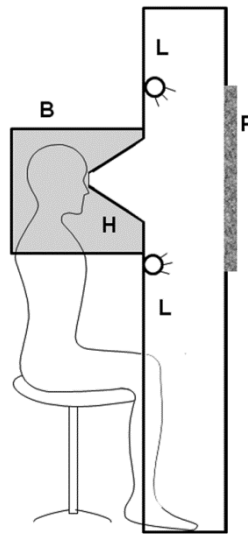

Fig. 3-1 Scheme of D-up viewer.

subject with a view of only the picture without any other images or light. A subject saw a picture P (38 cm wide by 25 cm high) through a hood H at the distance 27 cm from his/her eye which was pressed to the opening of the hood of the size 5 cm wide and 3 cm high with a good contact. The subject head was covered by a box B opened to the back of the head to eliminate stray light coming into the eye from surrounding. The view angle for the picture was 70° wide and 50° high so as to give the same horizontal visual angle for the front wall of the experimental room. Inside the hood there were several black strips attached to the surround to cutoff the reflection from the inside surfaces of the hood. There were two 3-band daylight type fluorescent lamps L of $x=0.312$, $y=0.343$ and the color temperature 6,500 K, one above and one below to illuminate the picture uniformly. The picture P was placed on the back wall from behind so that it could be quickly changed to another picture by the experimenter.

3.2.2 Experimental room

The experimental room (100 cm wide, 200 cm deep and 216 cm high) was built to simulate a normal room including some decorations, such as a painting, books, dolls, artificial flowers, and others, and is schematically shown in Fig. 3-2. The walls, covered by a white wall paper with a slight texture, had a Munsell Value of about N9. Three fluorescent lamps of 3-band type were attached at the ceiling to illuminate the room. Two lamps at the outer sides were covered by orange films (orange series) by giving an emitted light with chromaticity coordinates of $x = 0.571$, $y = 0.400$ and the

color temperature 1,610K, or by blue films (blue series) by giving the light of the chromaticity coordinates of $x = 0.167$, $y = 0.201$. The spectral transmittance of the

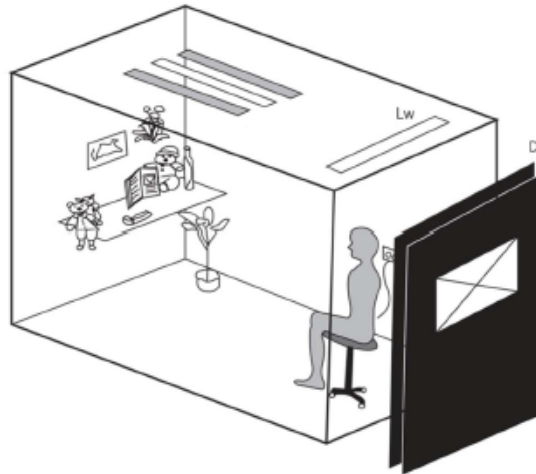

Fig. 3-2 Experimental room and D-up viewer (D).

films is shown by a solid line and a dotted line in Fig. 3-3, respectively. The intensities of the ceiling lamps were controllable independently with light controllers,

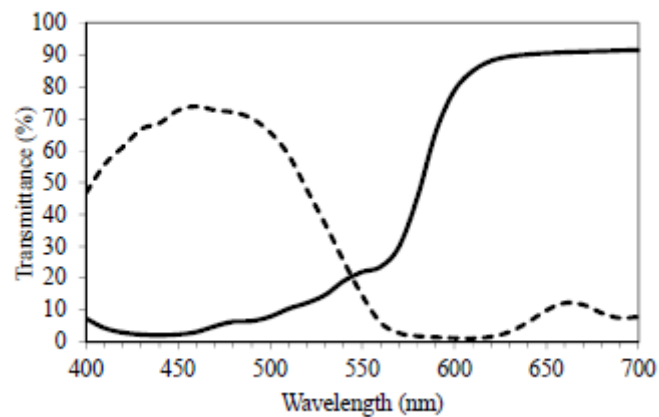

Fig. 3-3 Spectral transmittance of blue and orange films.

shown at the right hand of the subject in the schematic Fig. 3-2. By mixing the white light from the central lamp and orange lights or blue lights coming from the outer side lamps the room illumination of any color connecting the white and the orange point or the blue point on the CIE xy diagram was obtained. The subject sat down on a chair about 180 cm from the front wall to observe the room without a chin rest allowing

free movement of the subject's head as well as their eyes. There was another ceiling lamp L_w of the same daylight type near the entrance of the room. Just outside the room the D-up viewer D was placed and the subject inside the room could move out from the room to observe a picture in the D-up viewer.

Thirteen colors of illumination were prepared in the orange series for the experimental room by adjusting the ratio of intensities of white and orange lights but keeping the total illuminance at 80 lx, as shown by circles plotted on the right hand side in the xy chromaticity diagram in Fig. 3-4. Similarly thirteen colors of illumination were prepared for the blue side as shown by circles on the left hand side in Fig. 3-4. The colors were measured with a color luminometer pointing to the front

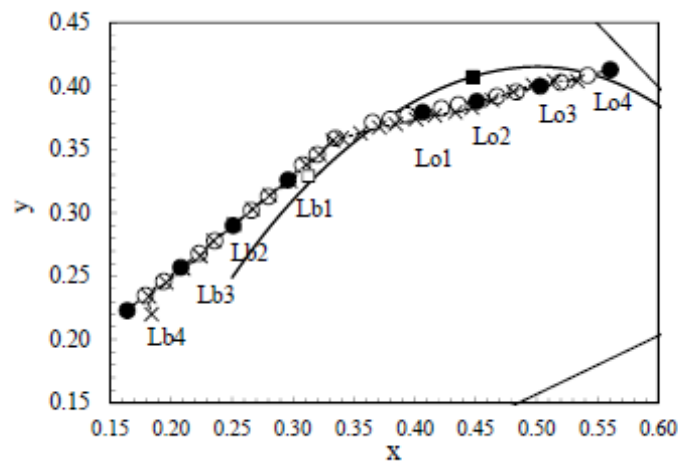

Fig. 3-4 Chromaticity coordinates of illuminations and picture stimuli.

white wall. The solid curve shows the black body locus, the open square the D65, and the filled square the A light source. Two straight lines at the upper right corner and at the lower right corner indicate the spectrum locus of the xy chromaticity diagram. For these twenty six illuminations color photographs were taken with a Nikon D90 camera from the position of the subject's eyes to be used as picture stimuli. The lens used was AF-S DX zoom-Nikkor, 12-24 mm f/4 GIR ED, 2x Zoom. The focal length of 20 mm was used. The white balance was d-0. The orange photographic series was printed by a photographic service shop by using matte papers and the blue series was printed by the inkjet printer, Canon i9950 at Chulalongkorn University by using IJ Photo Glossy Paper 260 g/m². The color of the front white wall in the picture was measured by the same color luminometer, with the results shown by symbol x in Fig. 3-4 for the orange series and the blue series, respectively. These photographs are denoted as P_{o1} , P_{o2} , ..., P_{o12} , and P_{o13} for the orange series and as P_{b1} , P_{b2} , ..., P_{b12} , and

P_{b13} for the blue series. P_{o13} and P_{b13} are the photographs taken under the most colorful orange and blue illumination, respectively. All the color shifted towards the left in the orange series implying that the color reproduction was not exact. It is, however, evident that the shift is mostly along the x axis in the xy diagram and so the x value was used hereafter to specify the color of illumination and of the picture stimuli. In the blue series the color reproduction was very good except the extreme left one because of the limit of the pigment color. The size of a picture stimulus was 38 cm wide by 25 cm high, the maximum available size by the printer of good quality at the photo-shop where we used.

The left picture in Fig. 3-5 shows a picture stimulus of blue series corresponding to the extreme left point in Fig. 3-4 and the right a picture stimulus of orange series corresponding to the extreme right point in Fig. 3-4. Figure 3-6 shows all twenty six picture stimuli in the orange series.



Fig. 3-5 Examples of picture stimuli, P_{b13} on the left and P_{o13} on the right.

3.2.3 Apparatus to confirm 3D perception

It was obvious to any subject that they perceived a 3D scene when they observed any of the twenty six photographs with the D-up viewer but we decided to confirm the perception experimentally by examining the visual property of the objects in terms of the shape constancy [26–29]. The retinal image of an object does not reproduce the exact shape of an object, yet we perceive the object in its original shape. The picture stimulus that we used in the present experiment had two angle frames at both sides which were not parallel but made a V-shape, as seen in Fig. 3-5. The angle of the apex of the V was 15.5° when measured from the outer edges of the frames. When we saw the real experimental room we didn't see the V-shaped frames but rather perceived parallel frames to indicate the shape constancy. We checked whether

a subject could perceive the parallel frames also if he observed the picture stimulus

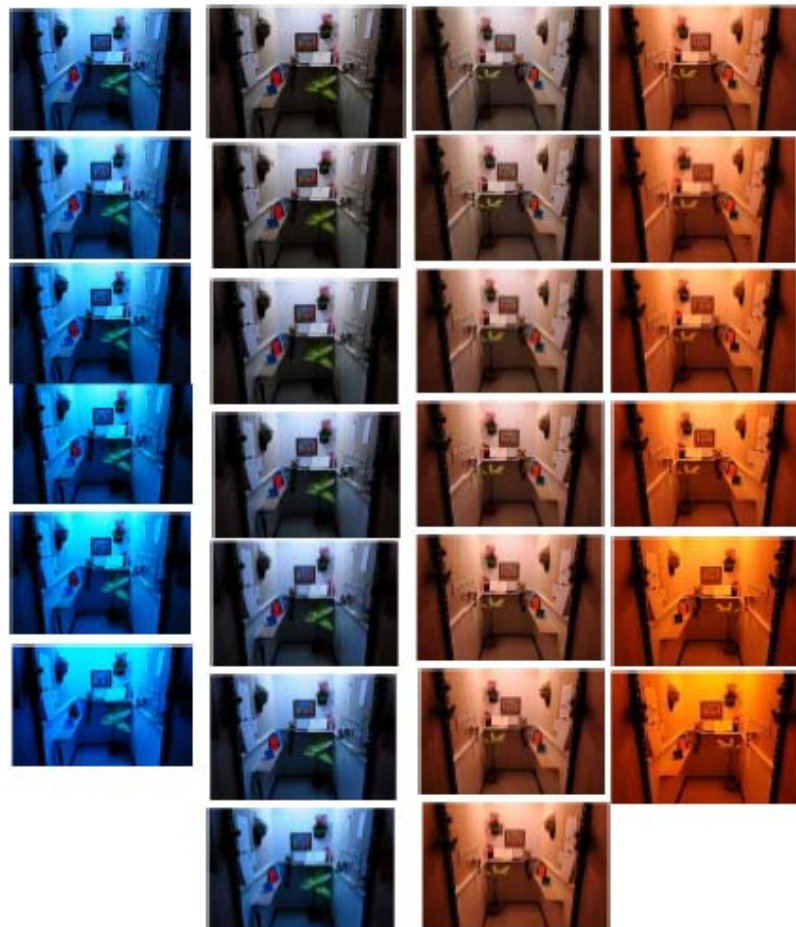

Fig. 3-6 Picture stimuli used in the experiment.

through the D-up viewer.

An apparatus was built to measure the perceptual angle for the V-shaped frames as shown in Fig. 3-7. It had two black bars to imitate two frames in the picture stimulus, which were placed on a white background of 60 cm wide and 27 cm high. The angle of the two bars was adjusted by manually changing the distance between the bottom sides of the two bars by pulling either one of two attached strings.

An additional pattern stimulus was made to evaluate the difference between a 3D and 2D perception as shown in Fig. 3-8. A picture stimulus from the blue series and a picture taken from a calendar were cut into pieces of the size $3 \times 3 \text{ cm}^2$, and they were randomly put together to make a mosaic pattern composing of 120 pieces to remove the perspective of the scene. Two black stripes were pasted on the mosaic stimulus at the same positions and with almost the same angle as the frames in the picture stimulus (15.6° vs. 15.5°).

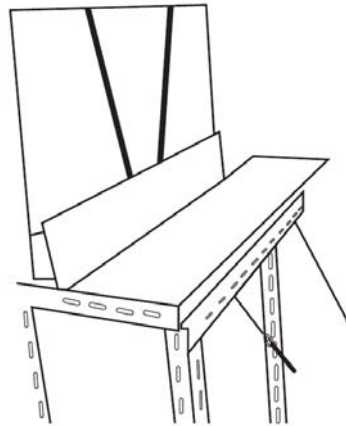

Fig. 3-7 Apparatus to confirm 3D perception.

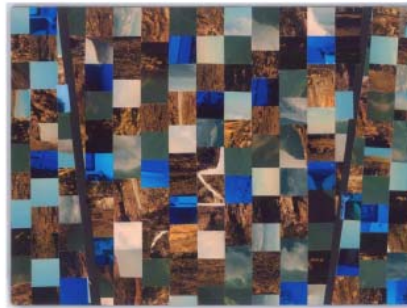

Fig. 3-8 Mosaic stimulus for a control experiment.

3.3 Procedure

3.3.1 Confirmation of 3D perception

We used two stimuli in this confirmation experiment, one the mosaic stimulus shown in Fig. 3-8, and the other a picture stimulus taken from the orange series. The experiment was carried out for two viewing conditions, normal and D-up. In the case of the normal viewing condition, the subject first looked at a stimulus placed on a table vertically inside the experimental room and illuminated by the L_w ceiling light at 80 lx, and then he/she turned around to see the two bars apparatus illuminated by the room light outside the experimental room. He then adjusted the angle of the bars to match to the angle of frames perceived for the stimulus. The subject could look at the stimulus as many times as he wished until he was confident of the bar adjustment. Then the subject proceeded on to another stimulus. In the case of the D-up viewing

condition the subject looked at a stimulus through the D-up viewer by one eye and then turned to the two bars apparatus to adjust the bar angle, as per the normal viewing condition. The same adjustment was carried out for another stimulus. The measurement was repeated ten times for each condition.

Five subjects, PW, JP, ET, BW and MI, participated in the experiment. Each had a good visual acuity.

3.3.2 Procedure for color constancy experiment

In the main experiment to show the color constancy, four different illuminations of increasing red spectra at the same illuminance of 80 lx (L_{o1} , L_{o2} , L_{o3} and L_{o4} in Fig. 3-4) were used. Another four illuminations of the blue series were also used, L_{b1} , L_{b2} , L_{b3} , and L_{b4} as shown in the same figure. The experiment for the orange series was done first and that for the blue series later. There were two viewing conditions, the D-up and the normal. In the D-up viewing condition, after the experimenter had adjusted the light of the experimental room to one of the four colors of orange series at 80 lx the subject was asked to enter the experimental room and to look around the room to remember the color of the room as a whole, presumably based on the various objects placed in the room. He/she was asked to wear a cap to avoid seeing the ceiling lamps, which give him the direct information about the illumination. When the subject thought he was ready he moved out from the room to look at a picture in the D-up viewer illuminated at 160 lx on the picture stimulus. The 160 lx illumination level had been determined beforehand to give the same brightness impression for the perceived room in the picture stimulus as for the real room. The experimenter set one of thirteen picture stimuli at the back of the D-up viewer. The subject ascertained a 3D perception for the picture and responded with “redder” or “whiter” to the picture stimulus presented in the D-up viewer compared to his memory for the color of the experimental room. The subject could look at the experimental room as many times as he wished until he could come to his decision. After the subject made their final decision, the experimenter changed the picture stimulus randomly to another one and the subject responded again. When a complete frequency curve of the response “redder” was obtained the experiment for that room illumination was over, and a redder frequency curve was obtained for another illumination. These processes were repeated until all the four illumination colors were investigated, when one session was over. Ten such sessions were obtained for each subject.

In the normal viewing condition the first step of observing the room was same as for the D-up condition above. When the subject was ready for the next step

he switched off the ceiling lamps, turned around, and switched on lamp L_w . He was handed a picture stimulus by the experimenter and observed it binocularly by putting the picture on a table right ahead of his at the distance of about 60 cm. He was asked not to gaze at the picture stimulus to avoid yielding any 3D perception on it. He observed the color of the picture stimulus and responded “redder” or “whiter” as before. To see the room again the subject switched off the L_w daylight lamp and switched on three ceiling lamps. When the subject gave the final response the experimenter handed another picture stimulus to the subject. Again the judgment was repeated until a frequency-of-redder curve was obtained.

Five subjects, SS, JP, PK, TK and MI, who all had normal color vision, as tested with the 100 hue test, participated in the experiment. The subjects JP and MI also participated in the 3D confirmation experiment.

For the blue series of experiment the similar procedure was employed as for the orange series. Subjects’ response was “bluer” or “whiter”. Five subjects, SS, JP, PW, ET, and MI participated in the experiment. Color vision the subjects PW and ET was tested with the 100 hue test as before and they showed normal color vision.

3.4 Results

3.4.1 3D confirmation

Results of the perceived angles of V-shaped frames of five subjects are shown in Fig. 3-9. Circles denote the result for the picture stimulus and triangles the result for the mosaic stimulus. The results obtained from the normal view condition are

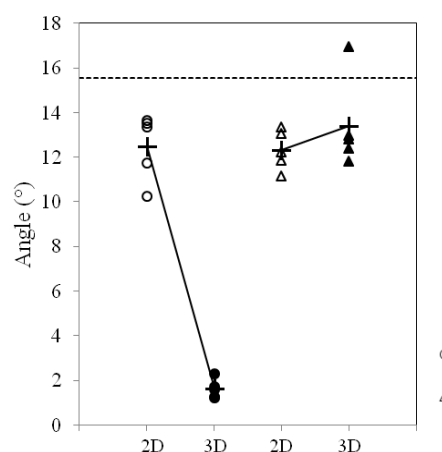

Fig. 3-9 Results of perceived angles of V-shaped frames.

shown by open symbols and from the D-up view condition by filled symbols. Five

points at each condition show the individual data. The averages of five subjects are indicated by crosses. The ordinate gives the perceived angle and a dotted horizontal line gives the angle of frames in stimuli. The angle perceived for the mosaic pattern is around 13° whether the normal or D-up viewing indicating there is no shape constancy at all. The angle for the picture stimulus showed quite different result. When it was observed by the normal view situation the perceived angle was close to the physical angle on the picture stimulus but when it was observed in the D-up viewer the angle became almost zero or subjects saw the frames of V shape as parallel. This implies that subjects perceived a 3D scene in the picture and the shape constancy took place. A space perception was confirmed for a picture when the D-up viewer was employed.

3.4.2 Results of color constancy

Figure 3-10 shows two data sheets filled with the subject JP's responses for

Illumination		Subject.....JP.....										
Pictures	x	1	2	3	4	5	6	7	8	9	10	R%
Po1	0.340											
Po2	0.356											
Po3	0.371	W	W	W	W	W	W	W	W	W	W	0
Po4	0.385	W	W	W	W	W	W	W	W	W	W	0
Po5	0.401	W	W	W	W	W	W	W	W	W	W	0
Po6	0.417	W	W	W	R	R	R	R	R	R	R	70
Po7	0.434	R	R	R	R	R	R	R	R	W	R	90
Po8	0.447	R	R	R	R	R	R	R	R	R	R	100
Po9	0.464	R	R	R	R	R	R	R	R	R	R	100
Po10	0.481											
Po11	0.497											
Po12	0.515											
Po13	0.534											

Illumination		Subject.....JP.....										
Pictures	x	1	2	3	4	5	6	7	8	9	10	R%
Po1	0.340											
Po2	0.356											
Po3	0.371											
Po4	0.385											
Po5	0.401											
Po6	0.417											
Po7	0.434											
Po8	0.447											
Po9	0.464	W	W	W	W	W	W	W	W	W	W	0
Po10	0.481	W	W	W	W	W	W	W	W	W	W	0
Po11	0.497	W	W	W	W	W	W	W	R	W	W	10
Po12	0.515	R	R	R	R	R	W	W	R	R	R	80
Po13	0.534	R	R	R	R	R	R	R	R	R	R	100

Fig. 3-10 Examples of data sheet.

the illumination L_{01} and L_{04} . Along the vertical direction the picture stimuli are taken and along the horizontal direction the session number. W denotes the response “whiter” and R “redder”. Picture stimuli were covered for investigation so that a full

curve of a probability-of-seeing curve was obtainable. In the case of the illumination L_{01} (upper sheet) picture stimuli covering P_{03} to P_{09} were investigated. The probability-of-seeing curves of these two sheets are plotted in Fig. 3-11 by circles for L_{01} and triangle for L_{04} . Along the abscissa the chromaticity coordinate x of picture stimulus is taken and along the ordinate the percentage of responding “redder” is

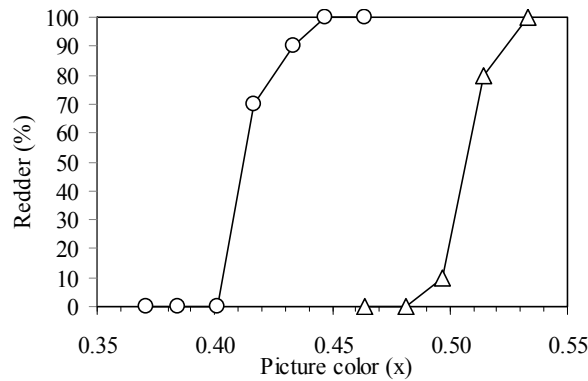

Fig. 3-11 Probability-of-seeing curves of redder response for two illuminations. Subject, CP.

taken. Probability-of-seeing curves of the orange series are plotted for all the five subjects and for all the experimental conditions in Fig. 3-12. The experimental conditions, as normal viewing or the D-up view, and with L_{01} , L_{02} , L_{03} or L_{04} illumination, are shown in each section. The x values of illumination employed are shown by filled circles for L_{01} , filled squares for L_{02} , filled diamonds for L_{03} and filled triangles for L_{04} , respectively, whilst the color of the white ceiling light and that of D65 are shown by short vertical bars for reference. The five curves correspond to the five subjects, as indicated at the top right. The slopes of the curves are sharp in most cases, indicating the easiness of the judgment “redder” or “whiter” for the picture stimulus presented to the subjects. The variance among five subjects was small for all the illuminations in the D-up views but it increased gradually for more orange illumination in the normal viewing. In the latter viewing condition subjects should compare the color of the 3D space of the experimental room and the color of the 2D plane of the picture stimulus. This asymmetrical comparison might have caused a subject-dependent variation in the judgment.

Probability-of-seeing curves of the blue series are plotted in Fig. 3-13 as in Fig. 3-12. The ordinate represents the percentage of “bluer” response. Individual variance is about same for all the condition and not so large.

The average of five subjects was calculated for Fig. 3-12 and Fig. 3-13. Values x

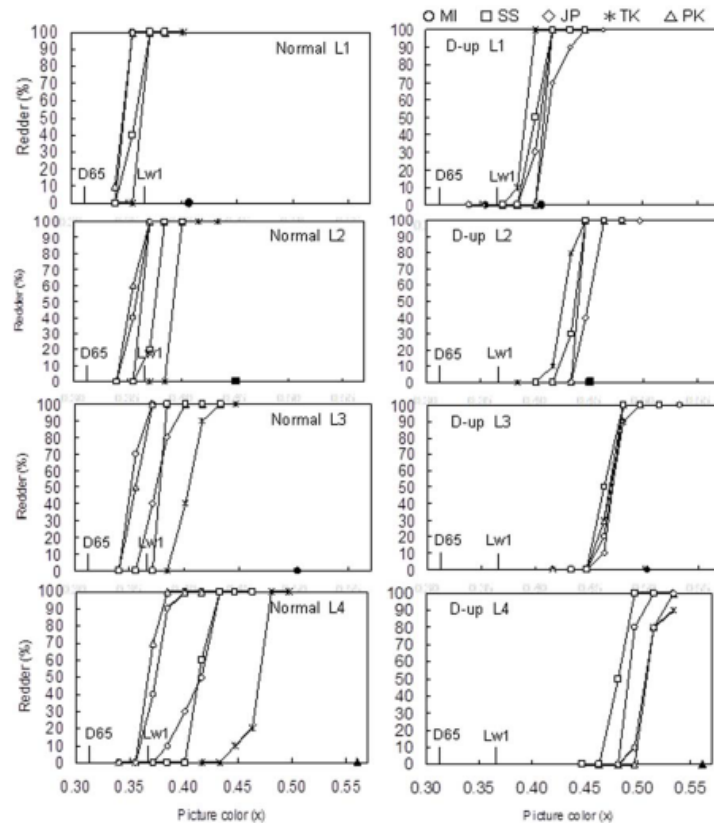

Fig. 3-12 Probability-of-seeing curves of redder response plotted for five subjects.

of the percentages, at 10, 20, 30, , 80, and 90, were extracted from each curve by interpolating between the neighboring two data points and the five values of subjects were averaged. For 0 % response in the case of orange series the maximum x values of subjects were averaged while for 100 % response the minimum x values of subjects were averaged. In the case of blue series the maximum x values were averaged for 0 % response and the minimum x values were averaged for 100 % response. The mean results for the five subjects are shown in Fig. 3-14 for the normal viewing condition at the top and the D-up viewing conditions at the bottom. Orange series and blue series are plotted together. Illuminations are shown on the abscissa and notations such as o1 or b1 attached to curves correspond to the illuminations. With the normal viewing condition, where the five subjects observed the picture stimuli placed on a table in the experimental room illuminated by the white light L_w , all eight curves came near to a white region. That is, the subjects chose the white picture stimuli to match the color of the experimental room regardless of the orange or blue illumination in the room. Even when the room was illuminated by a very deep orange light L_{o4} the subjects still chose the picture stimuli color to be near to L_{o1} . Similarly

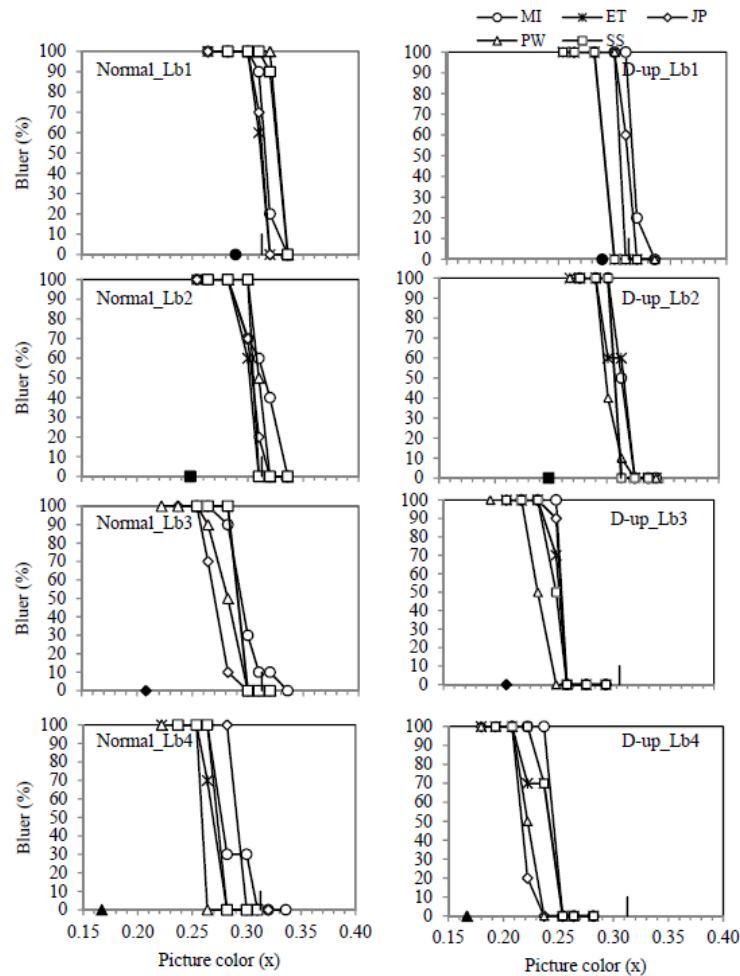

Fig. 3-13 Probability-of-seeing curves of bluer response plotted for five subjects.

the subjects chose picture stimuli of which x values are much larger than that of L_{b4} . These results can be understood if we accept that there is color constancy for the experimental room, which appears white, but no color constancy for the picture stimuli. Then, under this scenario, the subjects should choose the white pictures. The curves in orange series gradually shifted towards the right (redder) as the color of the experimental room became more orange. Using an illumination of 1,700, 2,400, 3,400, 6,000 and 30,000 K, Kuriki and Uchikawa [30] showed that the color constancy became less perfect as the room color became more orange. This imperfection of the color constancy for a real room might have taken place in our experiment with the subjects choosing a slightly more orange picture as the experimental room became more orange. The same property of deviating from the color constancy is seen in the blue series.

However, when the subjects used the D-up viewer to see picture stimuli the

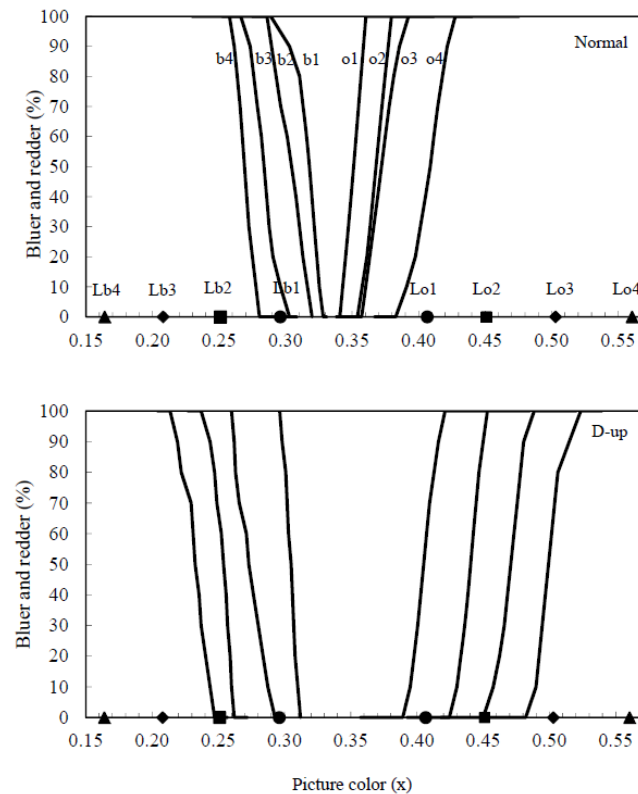

Fig. 3-14 Averaged probability-of-seeing curves plotted for x values; top, normal view and bottom, D-up view.

results were quite different. All curves of the orange series moved towards the right and were distributed in accordance with the level of red in the respective illumination. Subjects chose the picture stimuli of the color that was near to that of the real room. When the room was illuminated by an orange light the subjects also chose picture stimuli of a similar orange color to match the room in color. They did not see orange in the experimental room and nor did they see the orange color in the picture either. The same property is seen for the blue series. The subjects chose picture stimuli near to the color of the experimental room. Thus, color constancy took place for the pictures same as for the real room when the subjects perceived 3D spaces in the pictures. Because the curves did not come to the same point as the room illumination color, but remained a little bit at the whiter side, it then appears that color constancy did not take place in exactly the same manner as for the real room.

In plotting probability-of-seeing curves shown in Fig. 3-14 the chromaticity coordinate x was employed for simplicity. It was reasonable for the orange series as the color of illumination and the color of picture stimulus located on a relatively horizontal line on the xy chromaticity diagram as seen in Fig. 3-4. But in the blue

series the locations were on an almost 45° line and the use of only x value is not quite appropriate. We replotted curves in Fig. 3-14 by the distance along the lines of the orange series and of the blue series rather than x values. The distance was taken from the intersection point of two lines of the illumination color of the two series. The results are shown in Fig. 3-15.

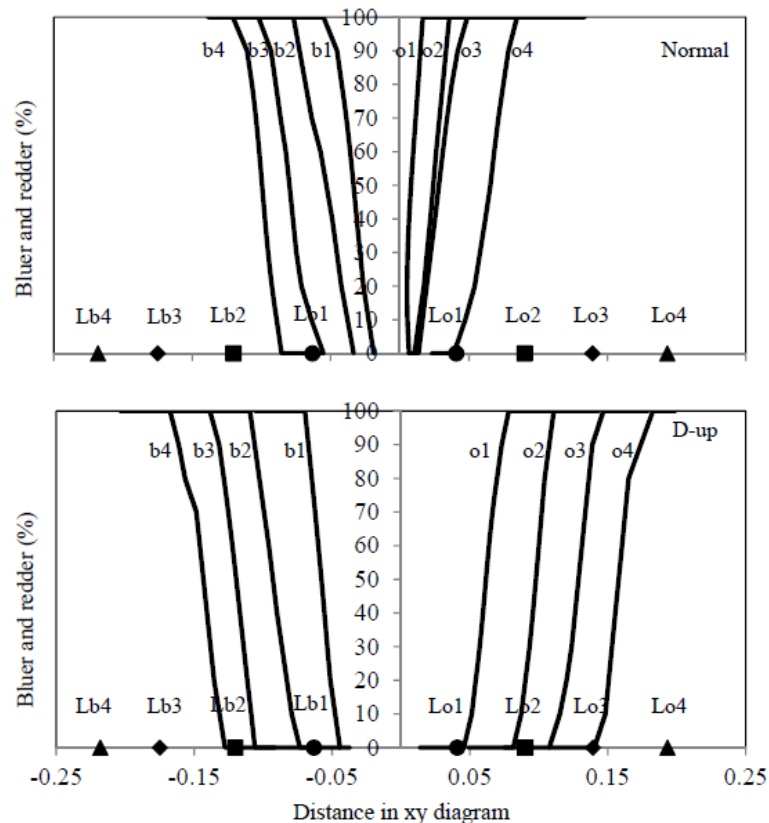

Fig. 3-15 Probability-of-seeing curves plotted for distance from a white point; top, normal view and bottom, D-up view.

To see the relationship between the illumination color of the experimental room and the color of the picture stimulus chosen for the room, the x values at 50% of the frequency-of-redder or -bluer response curves in Fig. 3-14 were plotted for the eight illumination colors as shown in Fig. 3-16. The abscissa gives the illumination color in x and the ordinate x value at the 50 % response in the chosen picture stimulus. Open diamonds are for the normal viewing condition and open circles for the D-up condition. A dotted line is a 45° line which gives the same color constancy as for the real room. The curves of the normal viewing condition have shallower slope than 45° to imply that the color constancy did not take place for the picture stimuli and

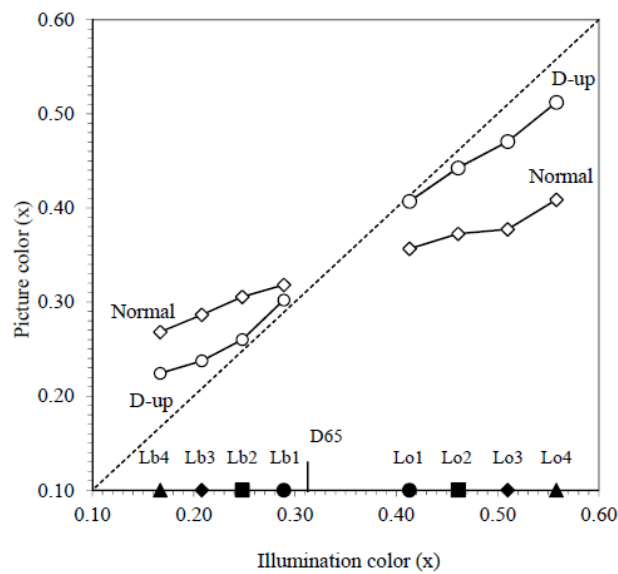

Fig. 3-16 Picture colors vs illumination colors plotted for normal view (open diamonds) and D-up view (open circles). Filled symbols on the abscissa indicate the color of illumination.

they just acted as a color scale for matching to the color of the experimental room. On the other hand, the curve of D-up viewing condition came very close to the 45° line with L_{o1} and L_{o2} in the orange series and with L_{b1} and L_{b2} in the blue series indicating the degree of the color constancy in the picture stimuli as for the real room. The curve gradually deviated away from the 45° line for the deeper color illuminations. Thus, the picture stimulus seems to have some limitation in being able to present the color constancy, as in the real room situation, when the stimulus is too vivid an orange or blue. That is the picture could not reproduce the same color appearance as the real room when the room illumination became too orange or too blue.

3.5 Discussion

The color constancy took place in a photograph if the photograph was perceived as a 3D space. How good the color constancy? This can be given by the vertical difference from 45° line to the data point in the graph shown in Fig. 3-16. In the D-up situation the difference is close to zero to indicate that the color constancy in photographs is very close to the real room. Nevertheless, the color constancy for a picture was not as good as for the real space when the illumination became more orange as shown by the deviation of the D-up curve from the 45° line. When, for example, the room was illuminated by L_{o4} the subjects perceived more orange in the

picture stimulus than they did for the real room and they chose a whiter picture by about $x = 0.062$. We will explain this finding by RCSI concept. On the left hand side of Fig. 3-17 a RCSI is illustrated as in Fig. 2-2. The experimental room was illuminated by an orange light and the illumination axis IX may be drawn as the illustration at the angle θ . A white object O is shown in this axis as its colorimetric color coincides with that of the illumination. We know from our experience that the white object appears a little bit orange, which means that the recognition axis RX on which the color perception is achromatic locates near to but not equal to IX with a small residual angle $\Delta\theta$. The white object O appears orange as much as $\Delta\theta$. The residual angle $\Delta\theta$ is considered to increase for increase of θ as we know from our experience that a white object appears more colorful for more colorful illumination. The relation between $\Delta\theta$ and θ may be shown by a solid straight line as shown on the right hand side of Fig. 3-17. From our present result subjects chose picture stimulus of which colorimetric color was a little whiter than the real room. This can be understood if we assume a line $\Delta\theta$ - θ for picture stimulus steeper than the line for the real room as indicated by a dotted line. To obtain the same $\Delta\theta$ in the picture stimulus as for the real room a picture stimulus of smaller θ should be chosen, a smaller θ to mean a whiter picture.

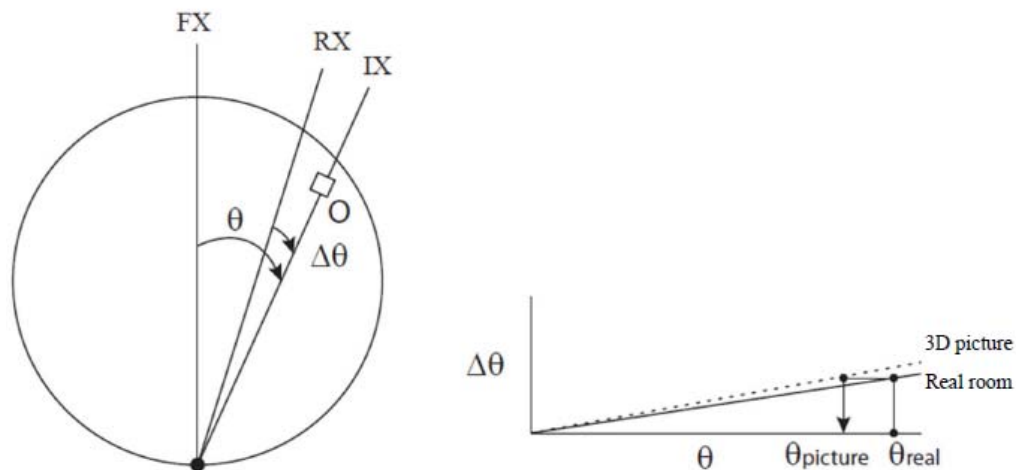

Fig. 3-17 Illustrations to explain the experimental results by RCSI.

Let us see the results from the normal viewing condition shown by open diamonds in Fig. 3-16. If the picture stimuli worked as a mere color scale in this condition without any color constancy in the stimuli the diamonds should lie one a line corresponding to the solid line in Fig. 3-17. In other words the line connecting

diamonds will give $\Delta\theta$ of the real room. In Fig. 3-18 the regression lines for the data points were obtained. The slope of the normal viewing condition will give $\Delta\theta$ change for θ for real room.

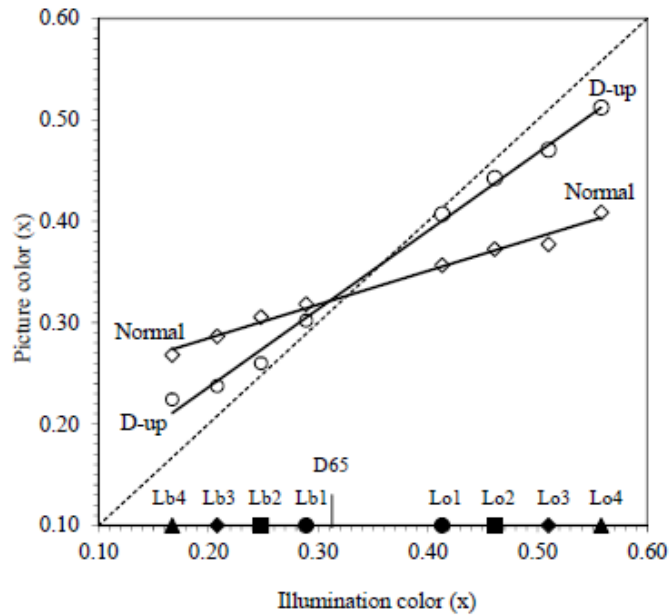

Fig. 3-18 Picture colors vs illumination colors plotted for normal view (open diamonds) and D-up view (open circles). Regression lines are drawn for the data.

CHAPTER IV

EXPERIMENT II: COLOR CONSTANCY IN PHOTOGRAPHS WITH STEREOSCOPE

4.1 Introduction

In the second experiment a technique of stereoscope was used to get 3D perception in photographs. Here, both eyes are used on the contrary to one eye in the D-up viewer. A pair of photographs was needed for any condition to be observed by the left and right eye, respectively.

The experiment was done at Ritsumeikan University, Japan while the author of the present thesis, Chanprapha Phuangsuan stayed at the university as a visiting researcher for nine months. A different experimental room from the one at Chulalongkorn University shown in Fig. 3-2 had to be used and a stereoscope should be built newly.

4.2 Apparatus

4.2.1 Stereoscope

The stereoscope built at Ritsumeikan University is shown in Fig. 4-1, the top view on the left and the front view on the right. Two first surface mirrors M_L and M_R

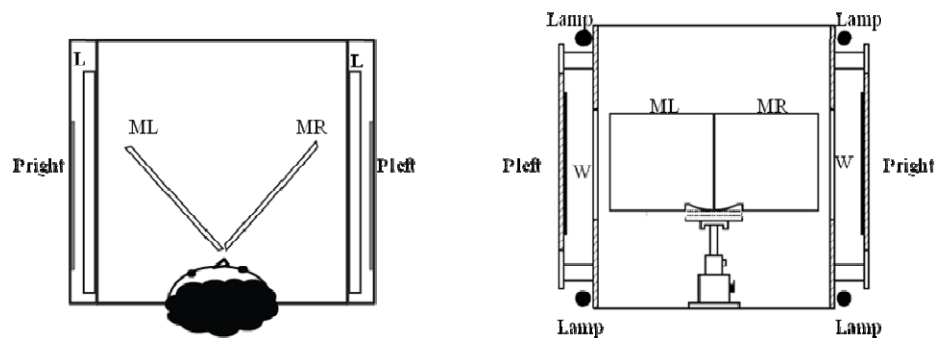

Fig. 4-1 Schematic view of stereoscope; left, top view and right, front view.

were placed to make a V-shape with the apex angle 90° . The size of each mirror was 40 cm wide and 20 cm high. The mirrors were placed in a box of the size 65 cm wide, 66 cm high, and 68 deep. One side of the box was opened so that a subject could put his/her head close to the apex of the mirrors. Inside of the box was pasted by black foam board. A pair of picture stimuli P_{left} and P_{right} was placed just outside the box so that the subject could see P_{left} with his/her left eye via the mirror M_L and P_{right} with

his/her right eye via M_R . The distance from the one eye to the center of the corresponding mirror was 17 cm and the distance from the center of the mirror to the picture was 39 cm, thus making the total viewing distance to the picture 56 cm. There were windows W between mirrors and the picture stimuli to limit the visual size for the stimuli to 40 cm wide and 20 cm high. These windows worked to present subjects only the view of picture stimuli. The visual angle for the picture stimulus became 39° wide and 20° high. Two fluorescent lamps of the 3 bands daylight type with $x = 0.335$, $y = 0.347$ were put at the upper side and the lower side of the picture stimulus to illuminate the stimulus uniformly.

There was a chin rest in front of the mirrors and subjects put their chin on it to fix their head position while they were observing picture stimuli.

4.2.2 Experimental room

There was an experimental room available already at Ritsumeikan University and a minor modification was necessary to carry out the present experiment, rearrangement of ceiling lamps, putting more objects in the room, and an addition of a normal viewing room. Figure 4-2 illustrates the experimental room. Its size was 130

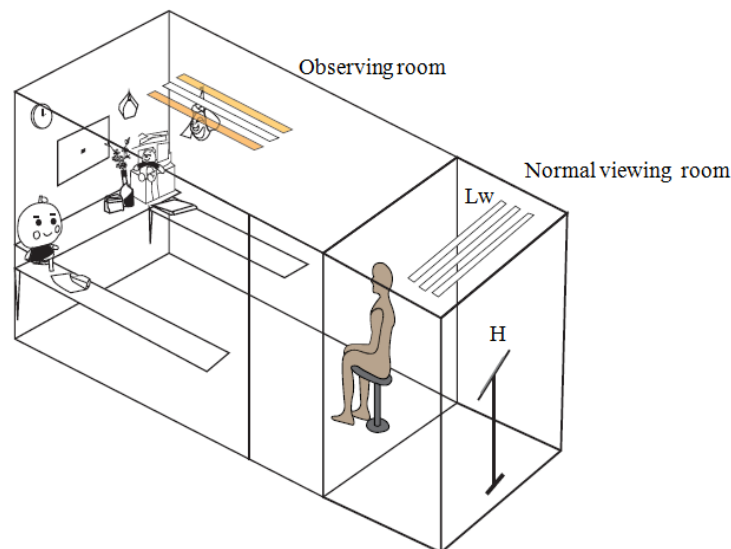

Fig. 4-2 Experimental room.

cm wide, 200 cm high, and 320 cm deep. It was composed of two rooms, an observing room and a normal viewing room with a separating curtain. The observing room had 220 cm depth and the normal viewing room 100 cm. Wall paper of N9 was pasted inside the observing room but a black curtain was used for the normal viewing

room. The arrangement of ceiling lamps was changed to meet the present experiment, namely three fluorescent lamps of same type as for the stereoscope were put on the ceiling of the observing room. Two lamps at both sides of the central fluorescent lamp in the observing room were covered by orange or blue color films which were brought from Chulalongorn University. Objects in the room were dolls, books, artificial flowers, a wooden mask, a clock and others. The illuminance was measured on the front shelf and it was kept at 80 lx. The distance from the front wall to the subject was 165 cm. There was an entrance on the left hand side of the subject. Figure 4-3 shows the front scene of the room. Three fluorescent lamps L_w of the same type as the ceiling lamps of the observing room were put at the ceiling of the normal viewing room. Below the lamps a picture holder H was placed so that a subject could observe a picture stimulus in the normal viewing experiment. The height of the picture stimulus when placed on the holder was 120 cm and the illuminance was 377 lx. The luminance was determined to make it same as for the luminance on the front wall of the observing room.



Fig. 4-3 Front view in the experimental room.

Twenty six colors of illumination were prepared by adjusting the intensities of the central lamp and the outside lamps of the observing room. The color was measured with a color luminometer, Konika Minolta CL200 at an above position of a small hole of the front wall. The experimental room was shared with some other student and a small square hole was used by her. The colors of the illumination are shown by circles on the CIE xy diagram in Fig. 4-4. A solid curve represents the black body locus, an open square D65 and a filled square the A light source defined by CIE. An open triangle indicates the chromaticity coordinates x and y of the 3 bands type fluorescent lamp used for the ceiling light when the color films were removed.

Fifty four photographs were taken for the 26 colors of illumination including the white illumination shown by an open triangle in Fig. 4-4, two photographs being taken for each illumination. A camera Nikon D300S was placed at the eye position of subject and two photographs were taken from the left and the right position with distance 6 cm as seen at the bottom in Fig. 4-5. The lens used was AF-S DX zoom-Nikkor, 12-24 mm f/4 GIR ED, 2x Zoom. The focal length of 20 mm was used. The white balance was d-0. We printed photographs on Epson Glossy Photo papers

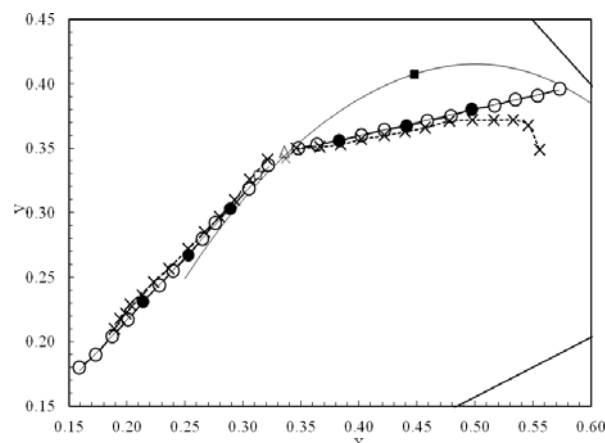

Fig. 4-4 Chromaticity coordinates of illuminations and picture stimuli.

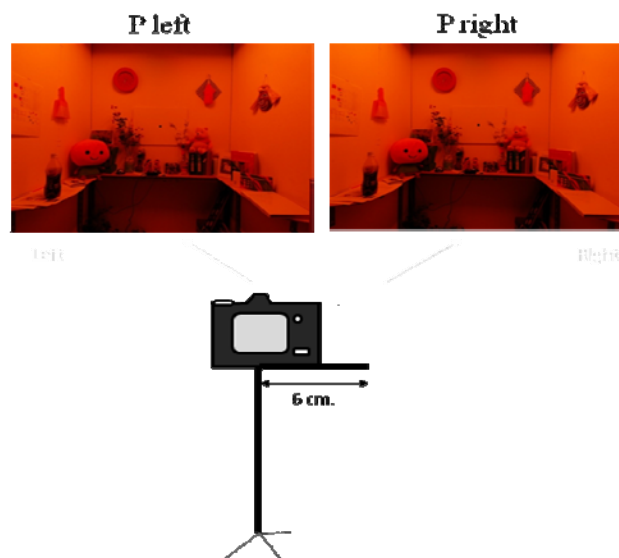

Fig. 4-5 A pair of picture stimuli (top) and the arrangement of a camera (bottom).

250 g/m² with an inkjet printer Epson Stylus Photo 1390 at Ritsumeikan University. The distance 6 cm was made equal to the distance of two eyes of the subject JP. The upper photographs in Fig. 4-5 show the left and right pictures, P_{left} and P_{right} , respectively. We can notice the difference between the two photographs by distance

between the left Pepsi bottle and the round head of the doll in the two photographs, the distance being longer on P_{right} than on P_{left} . The chromaticity coordinates of the forty six picture stimuli were measured at the same position for the real room through mirrors and the averages of the left and right picture stimuli are shown by xes in Fig. 4-4. A small x nearby the open triangle is for the picture stimuli taken under the white light and we call it P_w . The color reproduction is better than photographs used in Chapter 3 up to L_{09} and L_{b9} as these photographs were printed by an inkjet printer. There were deviations, however, from the illumination colors when the illumination became vivid orange and blue. In the orange side the color of the picture stimuli deviated from the color of illumination downward and in the blue side the color did not move enough following the color of illumination. Those picture stimuli were named as P_{01} , P_{02} ,,, and P_{b1} , P_{b2} ,,, as before, and those of P_{right} were shown in Fig. 4-6.

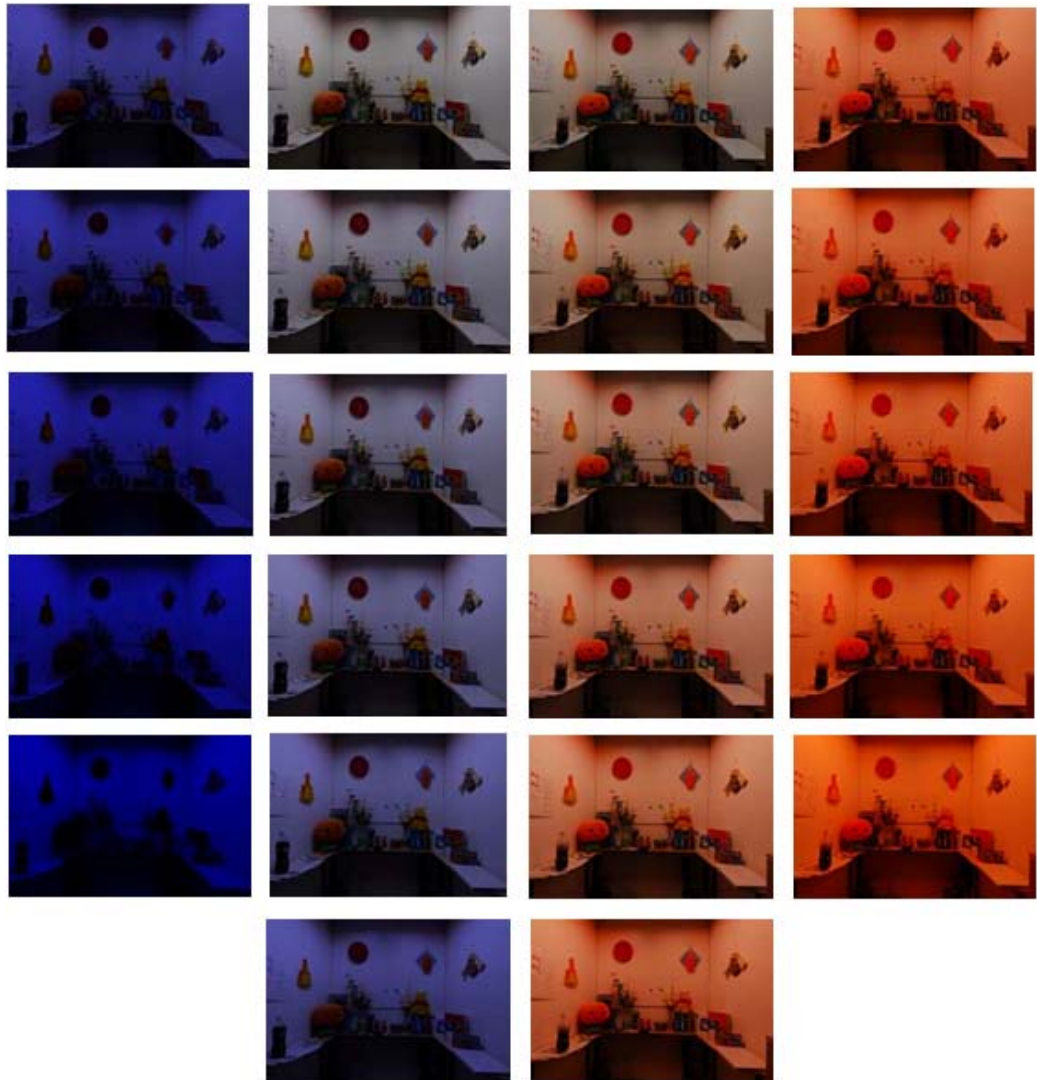

Fig. 4-6 Twenty two picture stimuli used in the experiment.

In the experiment P_{o12} , P_{o13} , P_{b12} , and P_{b13} were not used because of the deviation and we were obliged to limit the number of illumination to six.

The visual angle of the horizontal width of the front wall of the real room was 43° and that of the corresponding width on the picture stimulus was 14° . There is much difference between two visual angle but it was not possible to widen the visual angle of the picture stimulus because of the construction mechanism of the stereoscope.

4.3 Procedure

We did a preliminary experiment to decide the depth positions of picture stimuli to give a proper depth perception in the 3D scene. The positions were adjusted so that a subject could perceive the same depth perception as for the real room. This was done to each subject and the positions were recorded.

There were two viewing conditions, the stereoscopic viewing condition and the normal viewing condition. The experiment was divided to two series, the orange series and the blue series. In the stereoscopic viewing condition, when an experimenter set the color of the illumination to one of three orange illuminations, L_{o1} , L_{o2} , and L_{o3} shown in Fig. 4-4, and illuminance at 80 lx, a subject was asked to enter the experimental room and to adapt to the room for one minute. He/she was asked to look around the room and remember the color impression for the room. Then, he/she was asked to go out the room and look into the stereoscope S which was placed just outside the room as shown in Fig. 4-7. The experimenter put P_{left} and P_{right} to the stereoscope at the proper positions that were determined beforehand. The subject was asked to perceive a 3D space for the picture stimuli by spending one minute for the first time and to response “redder” or “whiter” compared to his/her color memory for the real room. The subject could confirm his/her color impression for the real room by returning to the room at any time. When the subject came to the final response the experimenter changed the pair of the picture stimuli to other pair. The subject was again asked to respond to the stimuli whenever he/she perceived a 3D scene. It took only a few seconds this time. Pairs of picture stimuli enough to cover responses of redder and whiter were investigated. When each pair was investigated for three times or four times the experiment shifted to the next illumination. When ten responses were obtained for the pairs of picture stimuli and complete probability-of-seeing curves for three illuminations were obtained the experiment for the orange series was over. A similar experiment was carried for the blue series although in this case the response was “bluer” or “whiter”.

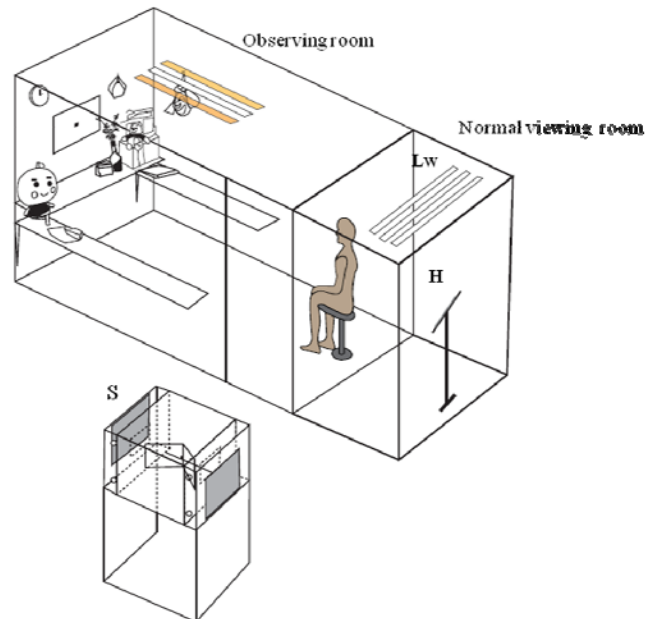

Fig. 4-7 Apparatus to show the experimental procedure. S, stereoscope; H, picture holder.

In the normal viewing condition subjects observed the real room as in the stereoscope viewing condition. Then they turned over to get into the normal viewing room and observed a right picture P_{right} placed on the picture holder. They judged the color impression of the picture stimulus and responded “redder” or “whiter”. The probability-of-seeing curves for three illuminations L_{o1} , L_{o2} , and L_{o3} in the orange series were obtained. Similarly probability-of-seeing curves for three illuminations L_{b1} , L_{b2} , and L_{b3} in the blue series were obtained.

Five subjects, KR, CP, ON, JP, and VS participated. The subject ON was a Japanese student and others were Thai. The subjects JP and VS were naïve subjects who were engaged to this kind of psychophysical experiment for the first time. All subjects were normal for the color vision when tested by 100 hue test.

4.4 Results

Probability-of-seeing curves obtained for the orange series in the normal viewing and the stereoscope viewing experiment are shown in Fig. 4-8. The abscissa gives the x value given in Fig. 4-4 and the ordinate the percentage of “redder” response. Symbols represent subjects. The left column gives the results of the normal viewing and the right column the results of the stereoscope viewing condition. The results of the illumination L_{o1} are shown at the top line and the illumination is shown

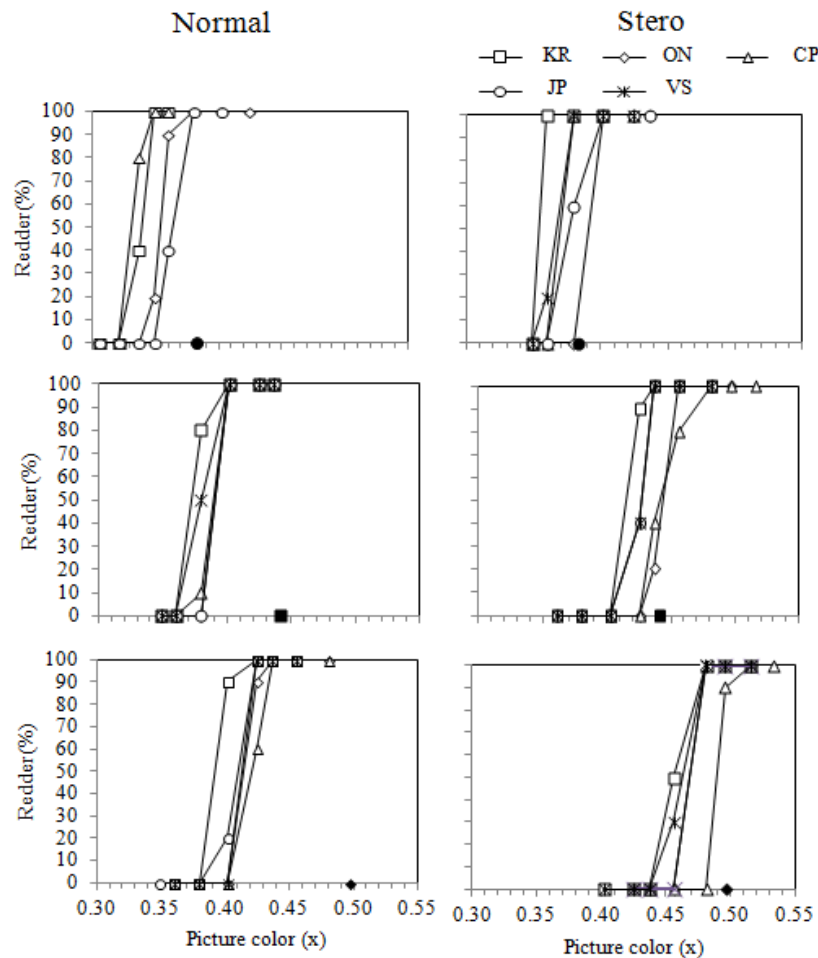

Fig. 4-8 Probability-of-seeing curves of redder response plotted for five subjects.

by filled circles on the abscissa. Those of L_{02} are shown in the middle with a filled square for the illumination and those of L_{03} at the bottom with a filled diamond for the illumination. There are five curves in each section corresponding to the subjects except the results of L_{01} and the normal viewing condition shown at the top left, where only four subjects' results were available. In fact subjects KR, CP, and VS gave redder response of 100 % even the picture stimulus P_{01} , which appeared already too reddish. In an additional experiment picture stimuli P_w , P_{b1} , and P_{b2} in the blue series were used with picture stimuli in the orange series to obtain the probability-of-seeing curve in a complete shape for illumination L_{01} for three subjects KR, ON, and CP. The subject VS was not available for the additional experiment. There are only four curves for the normal view condition and for the illumination L_{01} . Curves in Fig. 4-8 came close with each other for all the conditions. Figure 4-9 gives the results from the blue series experiment.

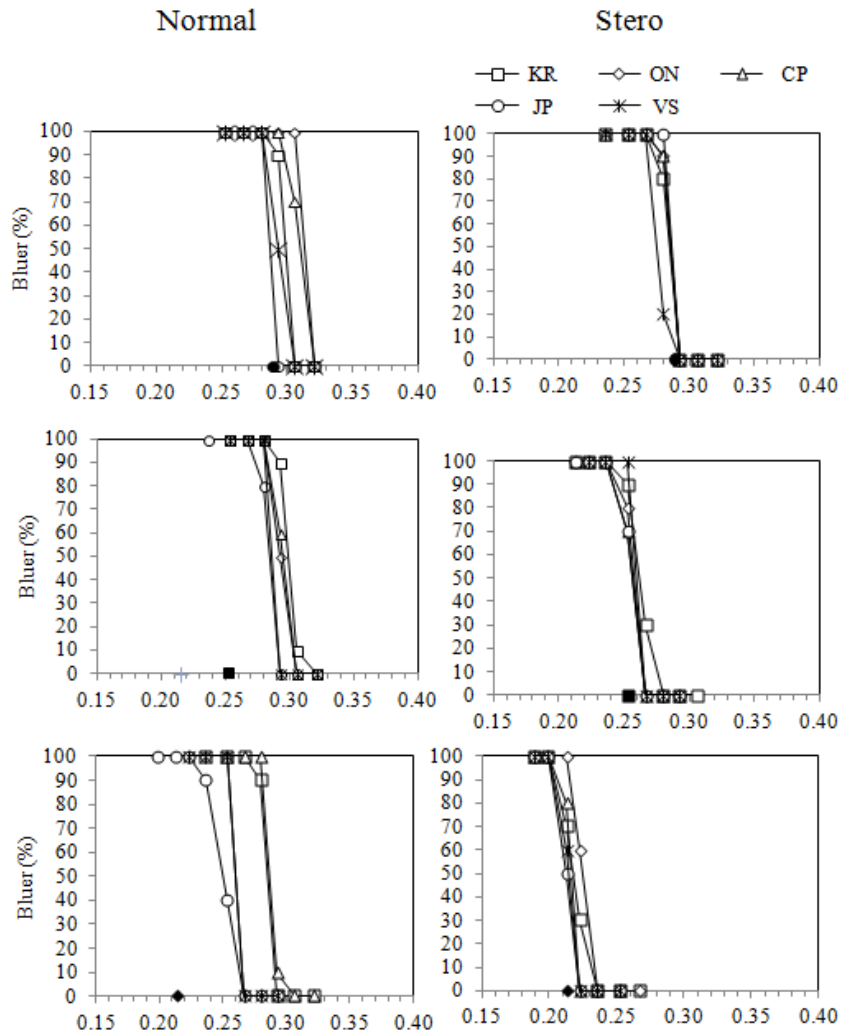

Fig. 4-9 Probability-of-seeing curves of bluer response plotted for five subjects.

The averages among five subjects were taken as in the case of Chapter 3 and the results are shown in Fig. 4-10, results from the normal viewing at the top and those from the stereo viewing at the bottom. The abscissa gives chromaticity coordinate x and the ordinate percentage of redder or bluer. Symbols on the abscissa show the illumination, filled circles for L_{o1} and L_{b1} , filled squares for L_{o2} and L_{b2} , and filled diamonds for L_{o3} and L_{b3} . The corresponding curves of probability of seeing are from the left, L_{b3} , L_{b2} , L_{b1} , L_{o1} , L_{o2} , and L_{o3} . Curves obtained from the normal viewing condition converged toward the center or white color implying that the real room appeared white and subjects chose white picture stimuli. On the other hand curves obtained from the stereoscope viewing the curves diverged so that their colors came close to the respective illumination colors implying that color constancy took place

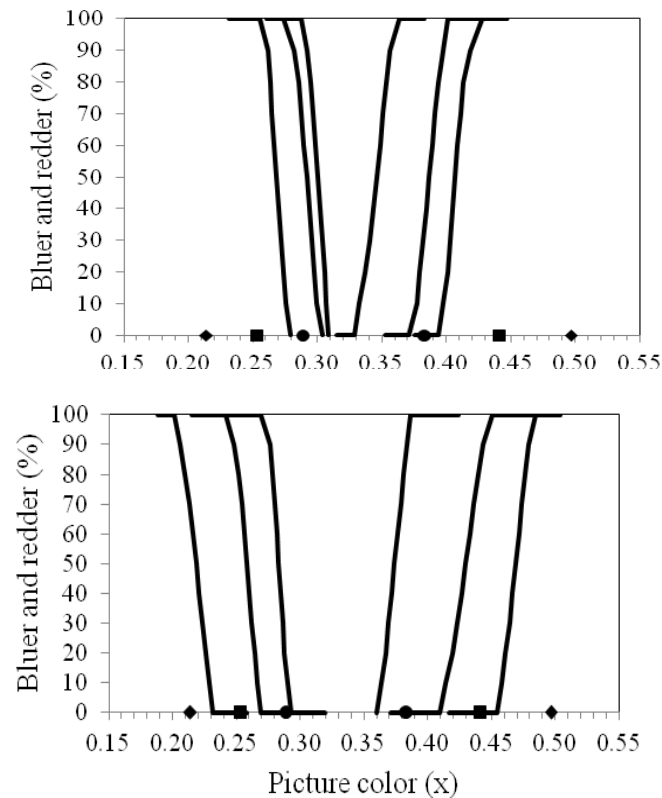

Fig. 4-10 Averaged probability-of-seeing curves plotted for x values; top, normal view and bottom, stereoscopic view.

for the picture stimuli.

By the same reason mentioned in Chapter 3 we changed the x values to the distance from the intersection point of two regression lines to fit circles in Fig. 4-4. The results are shown in Fig. 4-11. Distance in the blue side is taken negative. It must be noted that the curve corresponding to L_{01} obtained from the normal view had negative distance at low percentage.

To see the relationship between the illumination color of the experimental room and the color of the picture stimulus chosen for the room, the x values at 50% of the frequency-of-redder or -bluer response curves in Fig. 4-10 were plotted for the six illumination colors as shown in Fig. 4-12. The abscissa gives the illumination color and the ordinate x value at the 50% response in the chosen picture stimulus. Open diamonds are for the normal viewing condition and open circles for the stereoscopic viewing condition. A dotted line is a 45° line which gives the same color constancy as for the real room. The curves of the stereoscopic view came very close to the 45° line particularly in the blue series indicating the color constancy took place almost same as

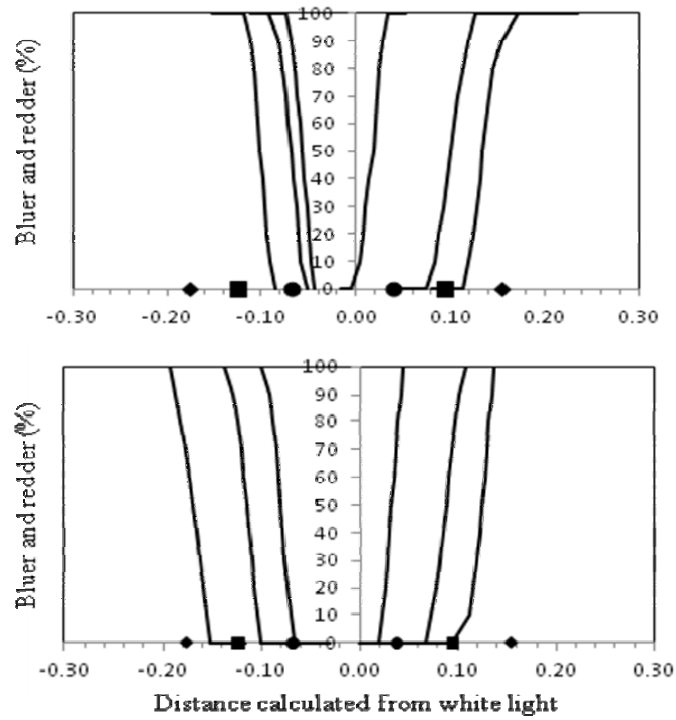

Fig. 4-11 Probability-of-seeing curves plotted for distance from a white point; top, normal view and bottom, stereoscopic view.

for the real room. The curve of the normal view have shallower slope than 45° implying the color constancy not same as for real room.

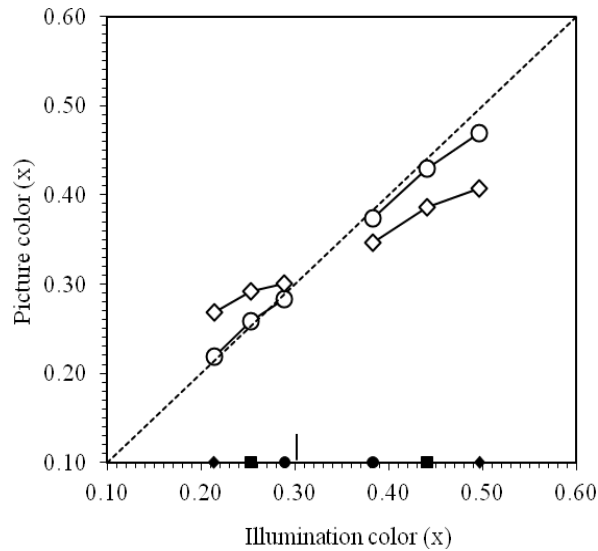

Fig. 4-12 Picture colors vs illumination colors plotted for normal view (open diamonds) and stereoscopic view (open circles). Filled symbols on the abscissa indicate the color of illumination.

4.5. Discussion

We showed that the color constancy took place in a photograph with the stereoscopic technique also. We obtained regression lines for the data given in Fig. 4-12 as shown in Fig. 4-13. The data are well represented by lines.

Subjects noticed that it was easier to have a 3D perception with the stereoscope compared to the D-up technique. The good color constancy particularly in the blue series might be related to the good 3D perception.

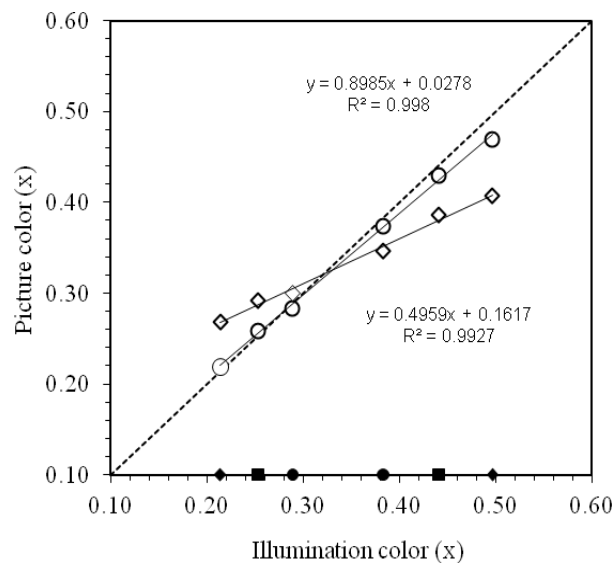

Fig. 4-13 Picture colors vs illumination colors plotted for normal view (open diamonds) and stereoscopic view (open circles). Regression lines are drawn for the data.

CHAPTER V

Experiment III; Color appearance of an achromatic patch on photographs viewed with D-up viewer

5.1 Introduction

It was shown that the color constancy of the visual system is the consequence of the adaptation to the illumination of a 3D space. A subject in a room recognizes the space and understands the illumination that fills the room. The understanding leads to the adaptation to the illumination and the recognition axis RX of the recognized space of illumination RVS_I rotates toward the illumination axis IX. If the illumination is reddish the IX comes near to the IX as illustrated in Fig. 5-1. A white object in the room is illuminated by the reddish light and its position is on the IX. The recognition axis RX is the axis of the achromatic perception and the white object appears almost white as the angle $\Delta\theta$ is small. This is nothing but the color constancy.

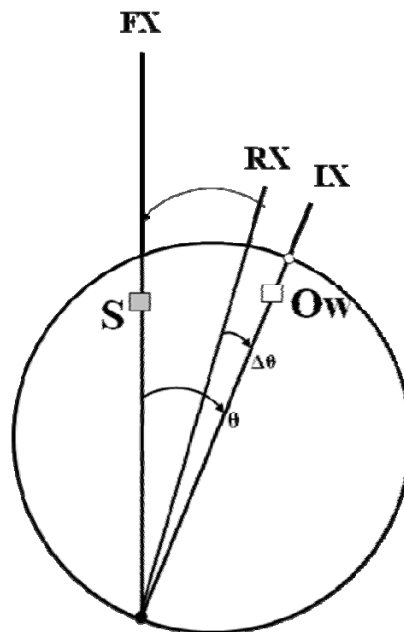

Fig. 5-1 Explanation of color appearance by RVS_I.

If we can present the subject a physically white stimulus without being influenced by the illumination, whose position in the RVS_I is on the fundamental axis FX as shown by S in Fig. 5-1, its color appearance is determined by the angle α and the direction from RX to FX. In the present case the direction is anticlockwise toward the green side. The color appearance should be green or greenish blue as we know from

the experiments done by Ikeda et al. and Pungrassamee et al. (Ikeda, Nakane, Shinoda, Pontawee and Ikeda).

Returning to the theme of the present thesis, the color constancy on a photograph, we can investigate the color appearance of an achromatic patch placed on a photograph viewed by the D-up viewer, which will be done in the present Experiment III. Same photographs used in Experiment I will be used and the color appearance of an achromatic chip placed on the photographs will be investigated and the color appearance will be compared with the color appearance of an achromatic stimulus placed in a real room.

The color appearance of the achromatic test patch was investigated in three ways as in Experiment I and II, the observation in the experimental room, the observation of pictures in the D-up viewer and the observation of pictures in normal viewing condition.

5.2 Apparatus and Experimental Condition

The same experimental room used in Experiment I but with addition of a test room was used in Experiment III as shown in Fig. 5-2. One of the ceiling lights L_w was not used here. At the bottom of the picture frame on the front wall a small hole W of $4.6 \times 4.6 \text{ cm}^2$ was opened so that a subject could see a test patch T placed in the test room through the window, which was 106 cm high of the eye level of the subject.

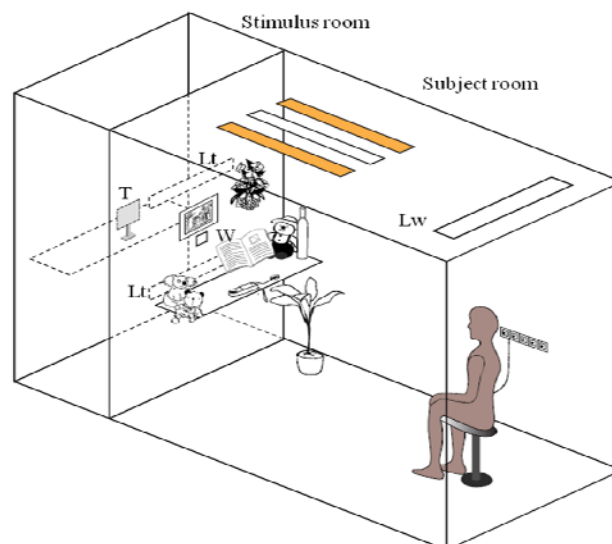

Fig. 5-2 Schematic view of the experimental room.

The visual angle of the window became $1.5^\circ \times 1.5^\circ$ arc when viewed at the distance

178 cm. An achromatic test patch T was placed in the test room at the eye level of the subject and at the distance 39 cm from the window W. The size of the test patch was $11 \times 11 \text{ cm}^2$, wide enough the subject can see the patch by both eyes. When the subject looked at the test patch through the window W the patch appeared as if it was pasted at the window and the subject recognized the patch as one of the objects placed in the subject room. The subject's task was to judge the color appearance of T by the elementary color naming method. The test room was illuminated by two fluorescent lamps L_t of the daylight type, same as other ceiling lights. The intensity of the lamps was controlled by a knob in the subject room. Figure 5-3 shows a picture of the experimental room. At the left bottom a subject is seen with a cap.

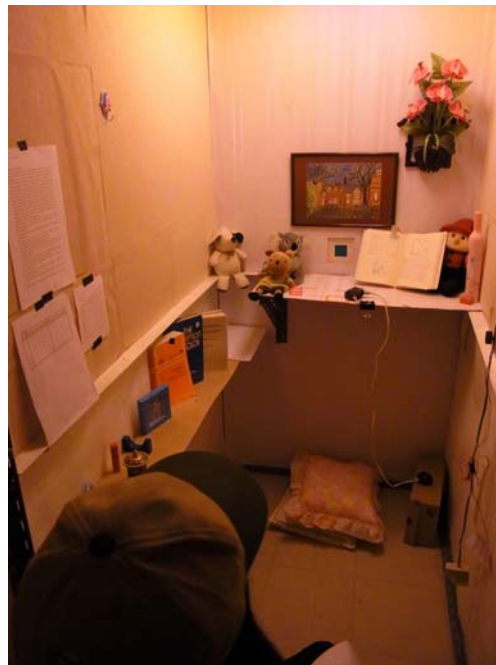

Fig. 5-3 A picture of the experimental room.

The same D-up viewer as in Experiment I was used as shown in Fig. 5-4. A subject pressed his head to a hood H so that he/she could see a picture P without having stray light coming from behind.

For normal viewing condition we wanted to have a really normal observing situation for pictures. A picture was put on a tripod as shown in Fig. 5-5 and a subject looked at the picture from a distance of about 90 cm. No chin rest was used to fix his/her head and the viewing distance was not fixed. The experiment was done in a normal room with ceiling lights and day light coming from windows. The illuminance

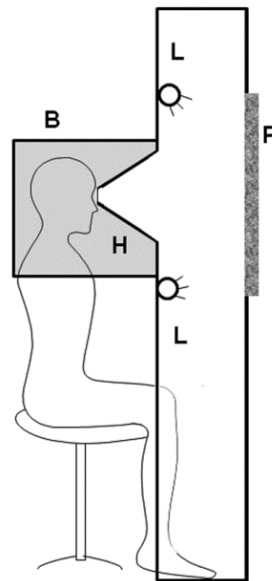

Fig. 5-4 D-up viewer.

around 400 lx on the picture, which varied depending on the time of the day of experiment.

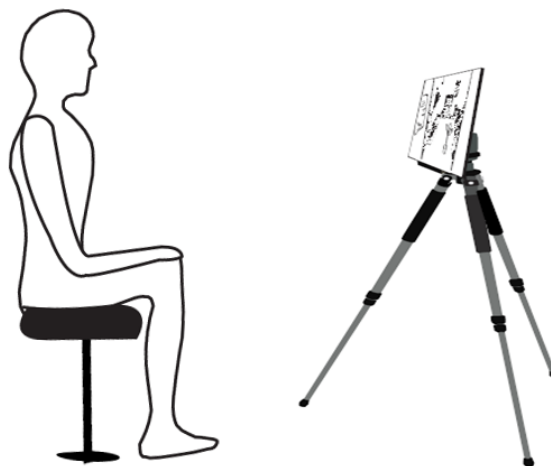

Fig. 5-5 Arrangement for the normal viewing experiment.

5.3 Preparation of Picture Stimuli

As in Experiment I thirteen illuminations of different color were prepared by adjusting the intensities of ceiling lamps of the experimental room while keeping the illuminance on the front shelf at 80 lx. The colors are shown by circles on the CIE xy

chromaticity diagram in Fig. 5-6. A solid curve indicates the black body locus, and the filled square shows CIE A light source and the open square D65. Thirteen photographs were taken for the experimental room under these thirteen illuminations, while the small window under the picture frame was closed. Hasselblad camera with Blackdigital Phase 1 iQ160 was used. The focal length was 80 mm and the lens was Hasselblad with f/16. The same photographic service shop as for Experiment I was used for printing. Matte papers were used. The color at the left side wall of the picture frame was measured by a color luminometer Konica-Minolta CL200 for all the thirteen photographs and they are shown by x in Fig. 5-6. The color reproduction is not good with a shift toward left in all the photographs. They were called P_{01} , P_{02} and so on up to P_{013} , o representing orange.

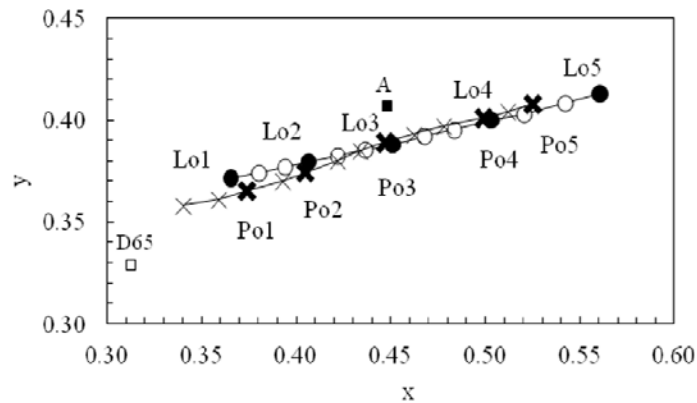

Fig. 5-6 Chromaticities of illumination (circles) and of photographs (x).

In the experiment the color appearance of the test patch given at the small window W was measured and five illumination colors L_{01} , L_{02} , L_{03} , L_{04} , and L_{05} were selected for the measurement. L_{01} was the case when the room was illuminated only by the center white lamp and L_{05} only by two outside lamps. We chose five nearest photographs to these five illuminations for the D-up experiment and for the normal viewing experiment. They are shown by thick xes and we called them P_{01} , P_{02} , P_{03} , P_{04} , and P_{05} . It must be noticed that there was no photograph to be close to L_{05} and we chose the nearest picture P_{05} to L_{05} . The five photographs are shown in Fig. 5-7.

At the same position in the photographs as a window W of the real room a square hole of the size $7 \times 7 \text{ mm}^2$ was cut out and a gray test patch was inserted in the hole to work as a test stimulus in the D-up experiment and the normal viewing experiment. The patch gave the same visual angle of $1.5^\circ \times 1.5^\circ$ as for the real room when viewed in the D-up viewer.



Fig. 5-7 Photographs used in the D-up and the normal view P_{01} to P_{05} corresponding to illumination, L_{01} to L_{05} .

5.4 Experimental condition and Procedure

Three stimulus patches were prepared, N3, N4, and N5 for color appearance measurement, and were inserted into photographs, thus making 15 photographs altogether. We first measured the luminance of these three patches and the wall on the left-hand side of the picture frame in photographs put in the D-up viewer with Konica-Minolta CL200. The illuminance on the photograph was kept at 160 lx same as Experiment I. Then the luminance at the left side wall of the picture frame and the luminance at the stimulus patch were measured to obtain the ratio of the two. The determination of the ratio was carried out for all the stimulus patches, N3, N4, and N5, and for photographs, P_{01} , P_{02} , P_{03} , P_{04} , and P_{05} . Table 5-1 shows the ratios thus determined.

Table 5-1 Luminance ratio between the wall and the stimulus patches in photographs.

ratio	N3	N4	N5
P_{01}	4.26	2.47	1.62
P_{02}	4.19	2.43	1.59
P_{03}	4.00	2.32	1.52
P_{04}	3.88	2.26	1.48
P_{05}	3.74	2.18	1.42

Now for the real experimental room we obtained the illuminance of the test room so that the stimulus patches placed in the test room gave the same ratio as for the photographs when we measured the luminance of the stimulus patches and the luminance of the front wall on the left hand side of the picture frame when the subject room was set at 80 lx. Table 5-2 gives the illuminance of the test room to satisfy the above conditions, when the illuminance was measured on the vertical plane on the back wall.

Table 5-2 The illuminance (lx) of the test room for combinations of stimulus patch and illumination of the subject room.

	N3	N4	N5
L ₀₁	80	139	217
L ₀₂	84	145	222
L ₀₃	87	151	232
L ₀₄	90	154	237
L ₀₅	93	161	243

For the real room experiment the experimenter chose one of the combinations of illumination color and the stimulus patch, such as L₀₂-N4, and set the room illuminance at 80 lx. A subject was asked to enter the room, to wear a cap to protect from seeing ceiling lights and to adapt there for two minutes. He/she was asked not to gaze at the stimulus patch during the adaptation but look around the room. The two minutes were long enough to reach a stable color for the stimulus patch. The subject judged the color of the stimulus patch binocularly and by the elementary color naming method. The amounts of chromaticness, blackness, and whiteness were judged in percentage, and then the amounts of redness, yellowness, greenness, and blueness were judged again in percentage. According to the opponent-colors theory the redness and the greenness are opponent with each other and there should not be perceived at the same time and at the same place. Also the yellowness and the blueness are opponent. Therefore, the subject could answer one or two hues without conflicting with the opponent-colors theory. He/she can say, for example, 40 % red and 60 % blue, or 30 % red and 70 % yellow, but not 20 % red and 80 % green. When the subject responded for a stimulus patch the experimenter changed the stimulus patch to another one. When all the three stimulus patches were observed for two times the experimenter changed the illumination and the subject responded as before after

adaptation for 45 seconds. When five illuminations L_{01} through L_{05} were investigated in a random order one session was over. The experiment for the real room situation was completed when all the combinations of illumination and stimulus patch were investigated for five times.

For the D-up experiment a photograph was placed at the back of the viewer by the experimenter and the subject was asked to look at the photograph monocularly. The adaptation time for the first view was 2 minutes or longer. Again the subject was asked not to gaze the stimulus patch during the adaptation. The subject could start to judge the color appearance of the stimulus patch after he/she certainly perceived a 3D space in the photograph. This was the most important condition for a subject to start the judgment of color appearance. The judgment was by the elementary color naming method as before. The experimenter changed the photographs one after another to complete all fifteen photographs, which made one experimental session. Before starting the next experimental session a subject was given a break of about 15 minutes. Five sessions were carried out with each subject. Figure 5-8 shows a subject observing a stimulus patch in a photograph with the D-up viewer.

For the normal viewing experiment a photograph was placed on a tripod and a subject judged the color appearance of the stimulus patch binocularly while he/she was engaged to some activities such as reading a book, looking at internet on a computer or talking with friends. No particular adaptation time was set. This situation



Fig. 5-8 A subject using the D-up viewer.

of observation was to simulate of looking at pictures in our daily life. The elementary color naming method was employed. In one experimental session fifteen photographs were observed and five such sessions were conducted. Between successive sessions a break of about 15 minutes was offered. Figure 5-9 shows a subject observing a photograph on a tripod in a normal laboratory. She was engaged to work with a computer while an experimenter changed the photograph.



Fig. 5-9 A subject doing the normal view experiment.

Five subjects, MI, PC, CP, SS, and RW participated to these three experiments, the real room experiment, the D-up viewing experiment, and the normal viewing experiment. In the D-up viewing experiment MI used his right eye, PC her left eye, CP her right eye, SS her right eye, and RW her right eye. The subjects MI and SS wore glasses. All the subjects had normal color vision as tested by the 100 hues test.

5.5 Supplemental experiment

In addition to the above three experiments a supplemental experiment for the D-up experiment and the normal viewing experiment was conducted to understand more about the effect of recognition of a 3D space in a photograph. The photographs P_{01} , P_{02} , P_{03} , P_{04} , and P_{05} were cut down into 1,102 pieces of each having the size $1 \times 1 \text{ cm}^2$. The pieces were randomly rearranged to make mosaic pictures as shown in Fig. 5-10 for the case of P_{04} , now called P_{mo4} . Four mosaic pictures were made, P_{mo1} , P_{mo2} , P_{mo3} , P_{mo4} , and P_{mo5} . A small square of the size $7 \times 7 \text{ mm}^2$ was cut out at the position for the stimulus patch and stimulus patches N3, N4, and N5 were inserted to the hole one by one at the experiment.



Fig. 5-10 A mosaic picture P_{m04} . T denotes the stimulus patch.

Two experiments were carried out for the mosaic pictures, the D-up experiment and the normal viewing experiment. The experimental conditions are same as before. Three subjects participated, PC, CP, and SS.

5.6 Results of Experiment III

In this experiment amounts of chromaticness, whiteness and blackness were measured for stimulus patches of N3, N4, and N5 and for five illuminations colors L_{01} , L_{02} , L_{03} , L_{04} , and L_{05} by the elementary color naming method. The results can be shown by graphs such as given in Fig. 5-11 similar to Ikeda et al.'s graph [24]. These are data from the real room experiment and for the stimulus patch N3. The result of the subject CP is shown above and that of the subject RW below. The illumination color is taken along the abscissa and the amounts of color elements along the ordinate; gray for the chromaticness, white for the whiteness, and black for the blackness. When the illumination was L_{01} , that is the closest color to white, the chromaticness was very small and the blackness was very large as expected for N3. When the illumination was changed to orange the blackness decreased while the chromaticness increased to show the chromatic adaptation to the illumination. The stimulus patch appeared more chromatic for more colorful illumination.

In the elementary color naming subjects also judged the apparent hue by the opponent-colors expression, which can be shown by a polar diagram shown in Fig. 5-12. Along the horizontal axis the redness R and the greenness G are taken in the opposite directions and along the vertical axis the yellowness Y and the blueness B are taken. The chromaticness is expressed by the distance from the center and it is 100 on the outmost circle. The hue change for different color of illumination is plotted in

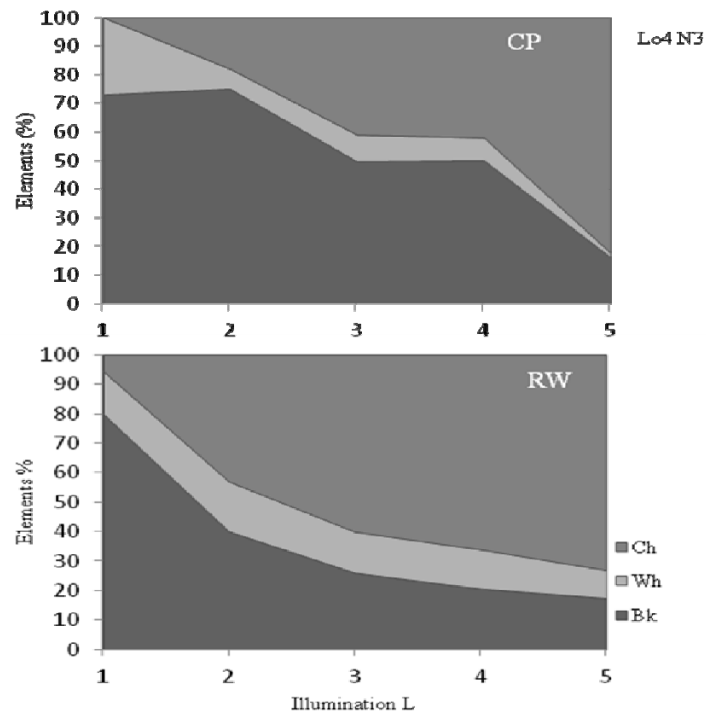

Fig. 5-11 Amounts of elements in percentage plotted for illumination L, chromaticness (gray), whiteness (white), blackness (black) for N3 in the real room experiment. Subjects, CP and RW.

Fig. 5-12 for the same subjects CP and RW as in Fig. 5.11 by open triangles for CP and open circles for RW, respectively. The points at the almost origin of the polar

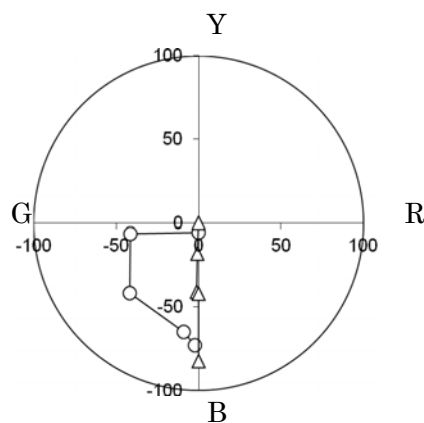

Fig. 5-12 Hue appearance change shown by a polar diagram for subjects CP (triangles) and RW (circles).

diagram are from the L_{01} condition and the outer most points are from the L_{05} condition. When the illumination became more colorful the color appearance of the stimulus patch N3 became more vivid. The change of chromaticness is from almost zero to 73 in RW and from zero to 82 in CP. In the case of RW the apparent hue first became green and then to greenish blue and finally to blue for illumination color. In the case of CP it was always blue and did not change for illumination color.

Graphs plotted as in Fig. 5.11 for all the subjects and for all the conditions are given in Appendix A.

To see the results exhibited in Fig. 5.11 easier the data are replotted for elements of the color appearance as shown in Fig. 5-13, upper for the subject CP and lower for RW. Along the abscissa the illumination is taken and along the ordinate the percentage of the amounts of elements. Five curves correspond to the experimental sessions. Three columns give the chromaticness, the whiteness, and the blackness, respectively.

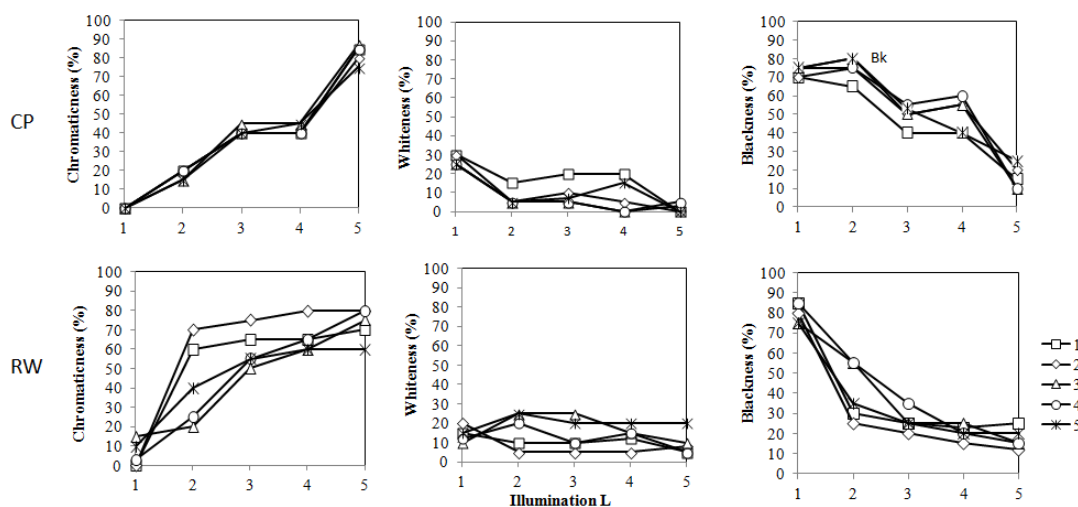

Fig. 5-13 Percentage of amounts of elements, the chromaticness on the left, the whiteness on the middle, the blackness on the right, from five sessions. Subjects, CP and RW.

Here the results are only for the stimulus patch of N3 and for the real room experiment. In this way the change of the elements for illumination color is more clearly seen. The chromaticness gradually increases for illumination, the whiteness stays more or less same, and the blackness gradually decreases. There are some variances among sessions but the properties just mentioned are clearly seen and the average of the five sessions can be taken.

Results of the stimulus patch N3 from all the five subjects are plotted in Fig. 5-14 for the three experimental conditions, the real room, the D-up, and the normal view, but for only the chromaticness. Five curves in each section correspond to five sessions. Variance among five sessions is small for the normal view and the real room,

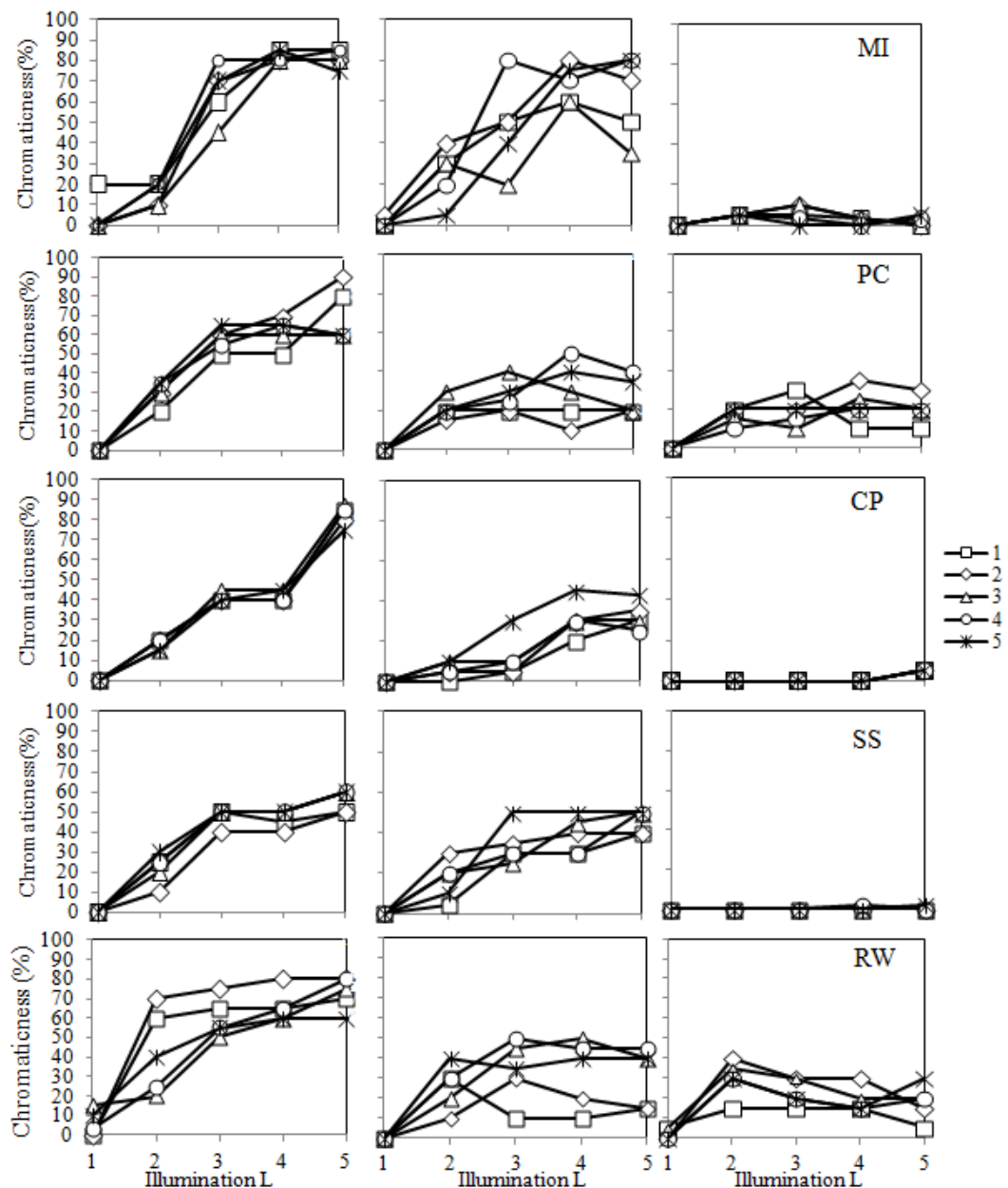

Fig. 5-14 Amounts of chromaticness for three experiments, real room, D-up, normal view for all the five subjects. Curves correspond to sessions.

but it appears large for the D-up. In the D-up experiment subjects were required to perceive a 3D scene in a photograph by only one eye and all the subjects commented

it was rather tiring to achieve experiment even one session. The unnatural seeing a 3D scene might have caused the fatigue and a large variance.

We averaged the data from five sessions and the results are shown in Fig. 5-15a, b, c for all the five subjects with different symbols. Again the abscissa shows the illumination and the ordinate the percentage of the mounts of elements. There are three columns and they represent the chromaticness, the whiteness, and the blackness from left. Three lines represent the stimulus patch N3, N4, and N5 from the bottom. In Fig. 5-15a the results of the real room experiment are shown, in Fig. 5-15b those of the D-up experiment, and in Fig. 5-15c those of the normal view experiment. Different symbols correspond to subjects, asterisks for MI, open squares for PC, open triangles for CP, open diamonds for SS, and open circles for RW. We see individual variance among five subjects in the most conditions but the tendency in the amounts of elements can be clearly seen. For example in Fig. 5-15a which gives the results for the real room experiment the chromaticness increased when the illumination was altered from L_1 to L_5 . The color appeared blue in most subjects. That is, the color appearance of the stimulus patch, whether N3, N4, or N5, changed to more vivid blue when the illumination changed from L_1 to L_5 . In the D-up experiment shown in Fig. 5-15b the property of increasing chromaticness for illumination can be seen also but in the normal viewing experiment shown in Fig. 5-15c the increase was very small or even zero in the subject SS (open diamond) showing no chromatic adaptation.

We took the average of five subjects' data in Fig. 5-15abc and plotted three elements together in one graph as shown in Fig. 5-16, chromaticness by open squares, the whiteness by open circles, and the blackness by filled circles. The purpose of the present experiment in Chapter 5 was to show the color constancy in a photograph by measuring the color appearance of a small stimulus patch placed in a photograph perceived as a three dimensional scene. Therefore we replotted the data of Fig. 5-16 so that the results of three different experiments can be compared directly, which is shown in Fig. 5-17. Three curves with open squares show the chromaticness, open circles the whiteness, and filled circles the blackness. Different experiments are shown by different lines, the solid lines for the real room, the dashed for the D-up, and the dot-dashed for the normal view. Let us first look at the chromaticness shown at the left column. In the real room experiment the amount of the chromaticness increased as the illumination color became more reddish. On the other hand the amount of chromaticness of the normal view did not increase for illumination change much and stayed low. The amount of chromaticness of the D-up took intermediate values. The amount was large with N3 and N4 coming fairly near to that of the real

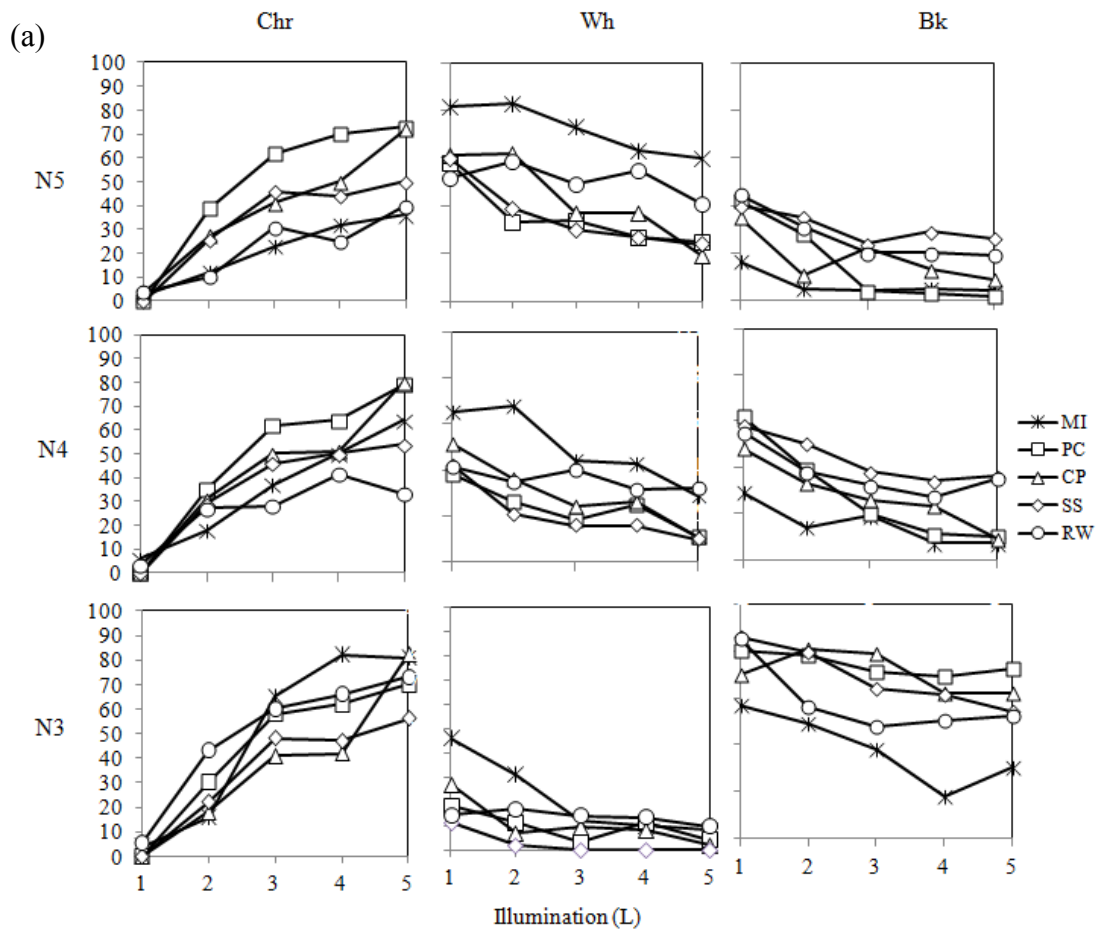

Fig. 5-15a Percentage of elements for illumination from real room, the left column for the chromaticness, the middle the whiteness, and the right the blackness, and the bottom line for N3, the middle for N4 and the top for N5. Different symbols are for subjects.

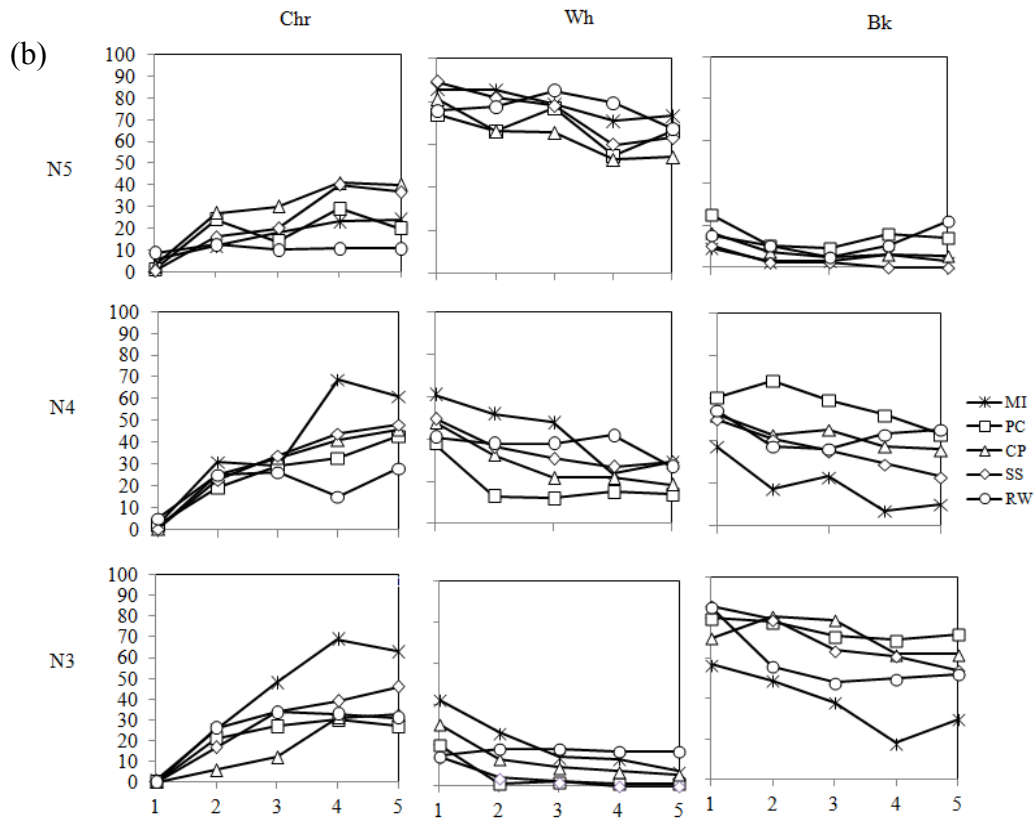

Fig. 5-15b Percentage of elements for illumination from D-up viewing, the left column for the chromaticness, the middle the whiteness, and the right the blackness, and the bottom line for N3, the middle for N4 and the top for N5. Different symbols are for subjects.

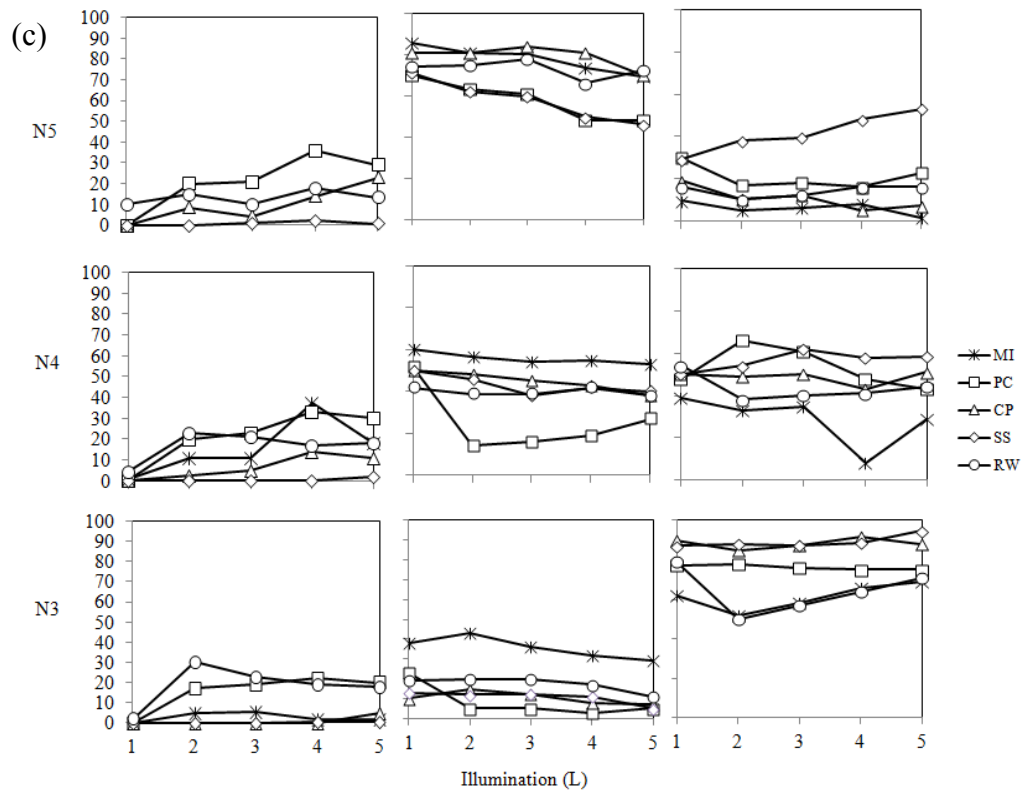

Fig. 5-15c Percentage of elements for illumination from normal viewing, the left column for the chromaticness, the middle the whiteness, and the right the blackness, and the bottom line for N3, the middle for N4 and the top for N5. Different symbols are for subjects.

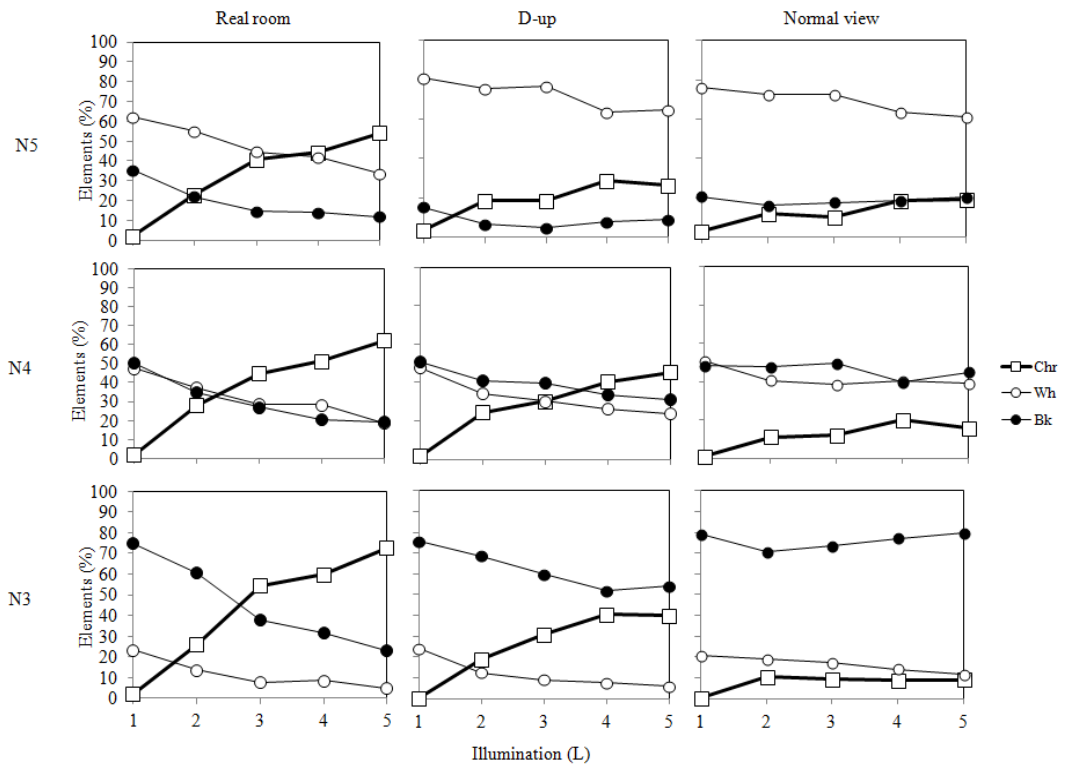

Fig. 5-16 Averaged percentages of the amounts of elements of five subjects plotted together, left column for the real room, the middle for the D-up, the right for the normal view. Results for N3, N4, and N5 are shown in different lines. Open squares, chromaticness; open circles, whiteness; filled circles, blackness.

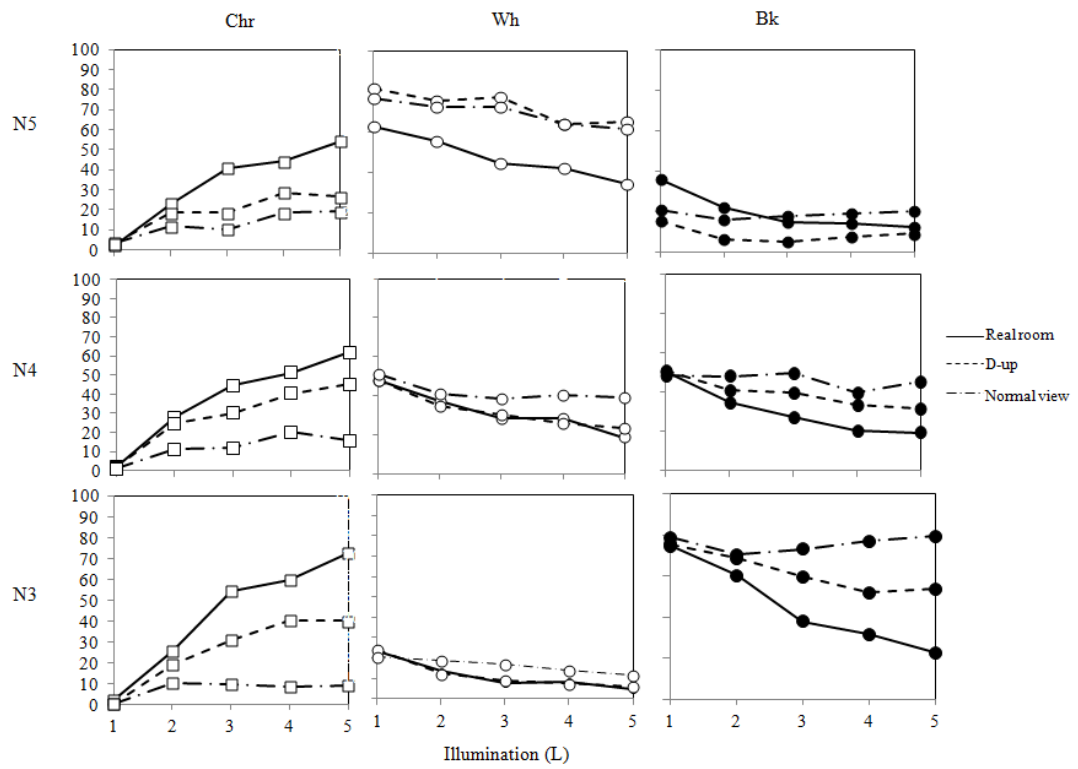

Fig. 5-17 Averaged amounts of elements from five subjects; chromaticness (left), whiteness (middle), and blackness (right); N3, bottom, N4, middle, N5, top.

Three curves correspond to real room (solid line), D-up (dashed), normal view (dot-dashed).

room experiment, which confirmed our insertion that the color constancy holds in a photograph if it is perceived as a 3D scene. But the fact that the amount did not agree with that of the real room indicates that the color constancy is not same as for the real room situation.

It is interesting to note that the curves of blackness are similar to the curves of the chromaticness but in up-side down direction. This should indicate that the blackness was replaced by the chromaticness for more reddish illumination. The results of N5 are different from those of N4 and N3. Its chromaticness was rather close to the chromaticness of the normal view while the chromaticness of N4 and N3 was near to the real room. The whiteness of N5 increased in the D-up compared to N4 and N3. The blackness of N5 decreased compared to N4 and N3. These results indicate that in the stimulus N5 the whiteness replaced the chromaticness and the blackness making the chromaticness smaller or the color constancy less in other expression. All the subjects reported that the appearance of N5 in the D-up experiment was a little bit unnatural. That is, the patch appeared too bright as an object in the space [31]. This change of the appearance might have caused the less color constancy in N5 in the D-up experiment.

Finally the hue appearance change for illumination is shown for all the subjects and for N3 only by polar diagrams in Fig. 5-18. Most subjects showed the hue change along B-axis except the subject RW who perceived green and greenish blue for intermediate color of illumination. Filled circles indicate the color appearance of the experimental room when it was illuminated by L_5 . The relation of the color appearance of the room and the color appearance of the stimulus patch will be discussed in chapter 5.7.

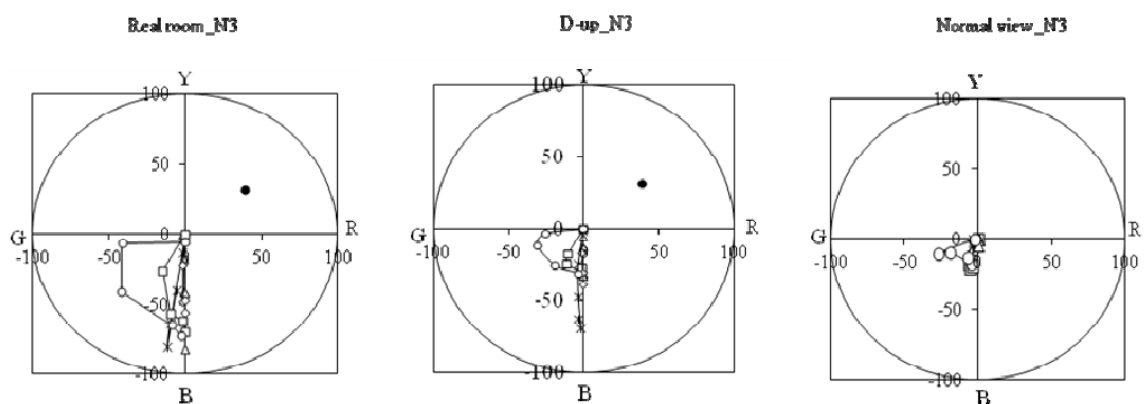

Fig. 5-18 Hue appearance change for illumination of five subjects; MI, asterisks, PC, open squares, CP, open triangles, SS, open diamonds, RW, open circles.

We did a supplementary experiment where we employed mosaic pictures shown in Fig. 5-10 in stead of a scene photograph. The photograph was observed in the D-up viewer and under normal viewing situation and the color appearance of the stimulus patches N3, N4, and N5 was investigated by the elementary color naming method. The results are shown in Fig. 5-19 as Fig. 5-11. The data for only N3 and for the subject PC are shown, the D-up at the left and the normal view at the right. The

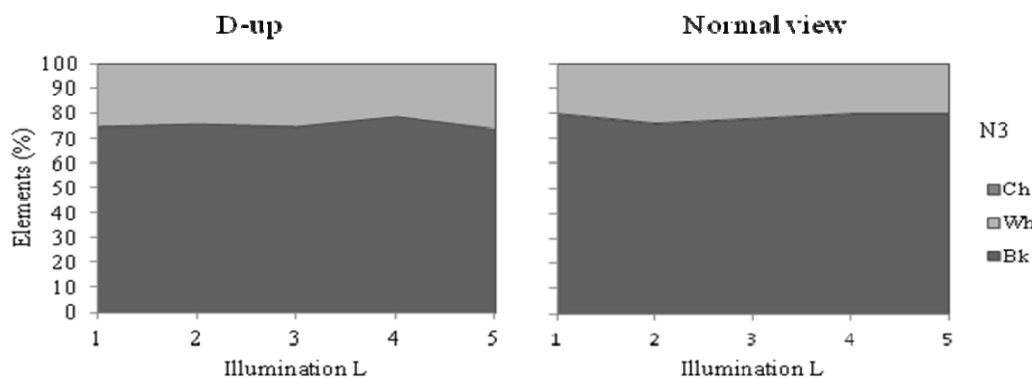

Fig. 5-19 Averaged amounts of elements of N3 for illumination in the case of D-up (left) and normal view (right). Subject, PC.

subject did not see color for the achromatic patch N3 at all for any illumination and the amounts of chromaticness and blackness remained almost same for the illumination change. To see the variance of five sessions in this subject the amounts of whiteness of N3 are shown for the five sessions in Fig. 5-20. The averages of the five sessions are shown by thick lines with filled circles. The average was taken for other two subjects, CP and SS, and the average of three subjects, PC, CP, and SS are taken to plot graphs in Fig. 5-21. It is quite clear amounts of all three elements stayed more or less constant for different illumination colors and the amounts of chromaticness were almost zero. The achromatic stimulus patches appeared achromatic in the D-up and the normal view experiment if the photograph was made of mosaic pieces that destroyed the perspective of the scene of the experimental room. When subjects could not perceive a 3D space no color constancy took place.

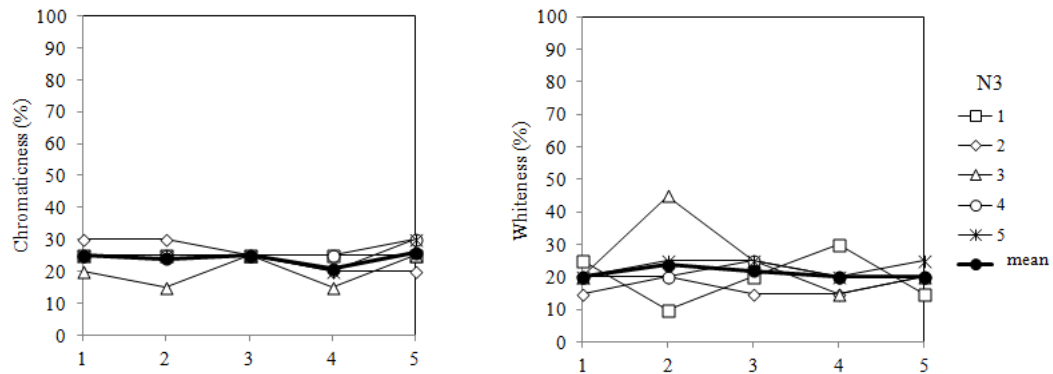

Fig. 5-20 Amounts of whiteness of N3 for illumination. Symbols correspond to sessions and the averaged amounts are shown by open circles connected by thick solid lines. D-up, left; normal view, right.

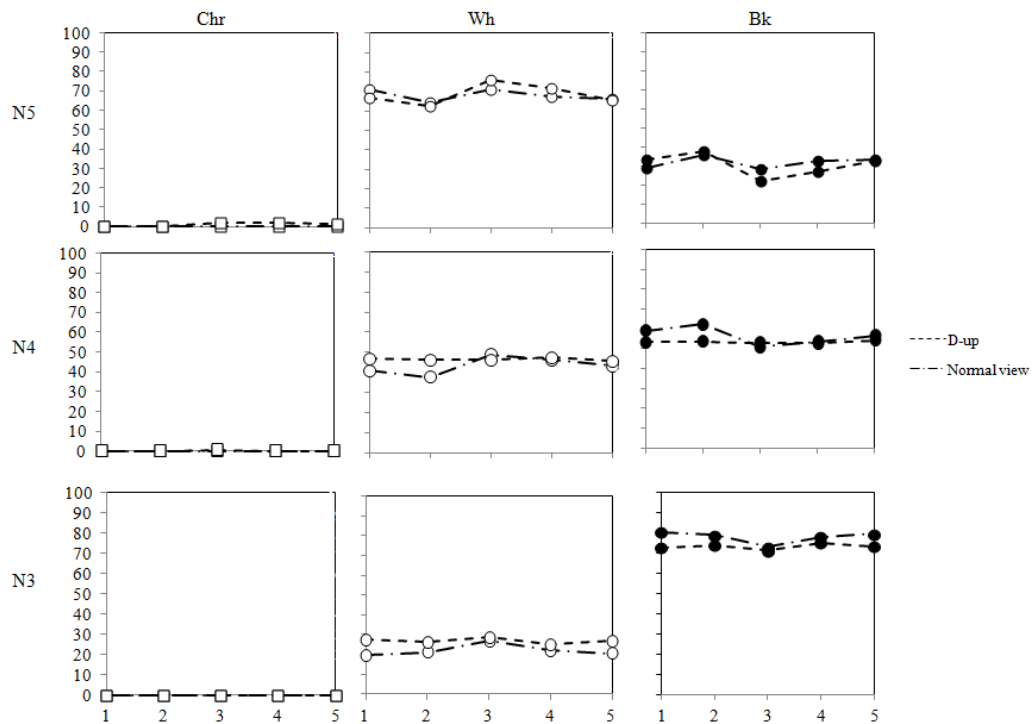

Fig. 5-21 Averaged chromaticness (left), whiteness (middle), and blackness (right) of three subjects, PC, CP, SS, plotted for illumination. Dashed lines, D-up; dot-dashed lines, normal view. Bottom three sections, N3; middle, N4; top, N5.

5.7 Discussion on Experiment III

We could show that the chromatic adaptation did not take place in a photograph when subjects looked at the photograph in a normal viewing way, that is to look at the photograph placed somewhere in a room. The achromatic stimulus patch remained

achromatic in appearance. But when subjects looked at the photograph in the D-up viewer and they perceived a three dimensional scene the color of the patch changed to vivid blue showing that the chromatic adaptation to the illumination in the 3D scene took place. This is to confirm that the color constancy can take place in a photograph if the photograph is perceived as a 3D scene. When we destroyed a 3D perception in a photograph by jumbling pieces of the photograph and making a mosaic picture the color of the achromatic stimulus patch remained even when the picture was observed in the D-up viewer. This result also confirmed that the 3D perception for a photograph was necessary to have the color constancy.

Let us interpret the present results by using the concept of the recognized visual space of illumination RVSI by using a figure like Fig. 5-1. The figure is shown in Fig. 5-22. In the case of the real room experiment the chromaticness increased as the

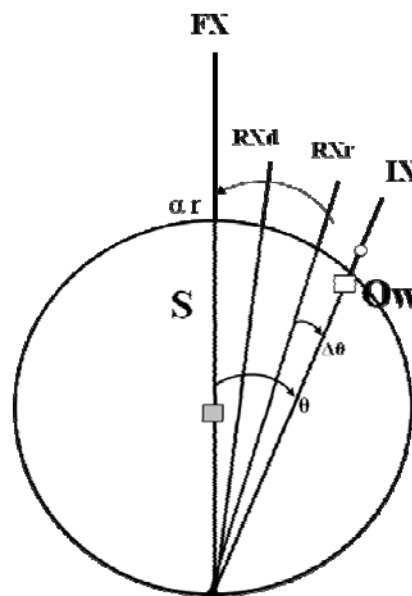

Fig. 5-22 Illustrations to explain the results by RVSI.

illumination became more reddish as shown in Fig. 5-17. This implies that the recognition axis RX_r followed the illumination axis IX as the angle θ became larger keeping the residual angle $\Delta\theta$ always small. The color appearance of a stimulus patch S was vivid as much as the angle α_r . This situation of keeping $\Delta\theta$ small in spite of the change of θ is nothing but the color constancy. In the results of the D-up experiment the chromaticness also increased for more reddish illumination showing the color constancy. However, the increase was not large as that of the real room experiment. This should indicate that the angle α_d is not as large as α_r and indicate that the recognition axis RX_d in the case of the D-up did not follow IX as much as RX_r

showing the less degree of the color constancy compared to the real room. It should be noticed that the chromaticness in the D-up is much larger than that of the normal view, particularly in cases of N3 and N4. In the case of the normal view the chromaticness remained very small for any illumination as expected. The environment light was daylight and the IX coincided with FX, the fundamental axis, and the color appearance of the stimulus patch was expected to be achromatic and we could confirm it as seen in Fig. 5-17. The fact then that the chromaticness of the D-up was larger than that of the normal view and near to the real room confirms that the color constancy took place in the photograph if it was perceived as a 3D scene.

The apparent hue of the stimulus patch N3 was unique blue in the real room and the D-up experiment in most subjects when the illumination was reddish as seen in the data lying on the B-axis in Fig. 5-18. When we measured the color appearance of the front wall of the real room from outside through a small window opened on the entrance door it appeared yellowish red. The average point of the color appearance from three subjects, PC, SS, and RW, is plotted by filled circles in Fig. 5-18. It is interesting to note that the color appearance of the stimulus patch N3 is not simply opposite to the color appearance of the room illumination, which should be greenish blue.

CHAPTER VI

GENERAL DISCUSSION AND CONCLUSION

6.1 General discussion on three experiments

Based on the recognized visual space of illumination RVSI theory we could demonstrate the color constancy in photographic images directly by D-up method (Experiment I) and by stereoscopic method (Experiment II) and indirectly by the color appearance method (Experiment III). With the D-up viewer subjects could perceive a 3 dimensional scene in photographs and then the color impression in the photographs was almost same as for a real room proving the color constancy in photographs. The similar results were obtained with the stereoscope. In Experiment III the color appearance of an achromatic stimulus patch pasted at the center of a photograph changed to a vivid blue when the photograph was the one taken under a vivid orange illumination and was seen with the D-up viewer. The result indicated that the visual system of the subjects adapted to the orange illumination perceived in the photograph, which according to the RVSI theory showed the color constancy.

These positive results to show the color constancy were observed in all the subjects participated in the experiments. This differs from results reported by Mizokami et al. [21]. They showed a large variance among subjects from a high to no color constancy, while we obtained almost the same color constancy as for a real space from all the subjects. We may mention different experimental methods among the two groups for the reason. Mizokami et al. employed a small test patch of the size 1.2° wide and 0.8° high placed in the stimulus picture, which is similar to our Experiment III, and asked subjects to choose a patch of the achromatic appearance. There was no reference color to compare with and the subjects had to determine the color of the test patch by so-to-say the absolute judgment. Each subject might have a different criterion for the achromatic perception causing a variety of results. On the other hand the subjects in our experiment could compare the color of a picture stimulus with the real room in Experiment I and II. The real room worked as a reference and the matching method made subjects' judgment easy to give consistent response. In the normal viewing experiment it was not difficult at all either to judge the color of the picture stimulus redder or whiter in the case of orange series and bluer or whiter in the case of blue series compared to the real room. The difference in the D-up tool may be mentioned. In the Mizokami et al.'s case subjects observed a stimulus picture of the size 27° wide and 21° high through a small window locating at some distance from the eye in the dimension-up viewing box, while in our case they

observed a stimulus picture of the size 70° wide and 50° high with the eye pressing the opening of the hood eliminating the feeling of the window observation. The larger visual field and the elimination of visual information other than the stimulus picture in the present method might have offered the subjects a stronger space perception as confirmed in Fig. 3-9 and led to high color constancy to all the subjects.

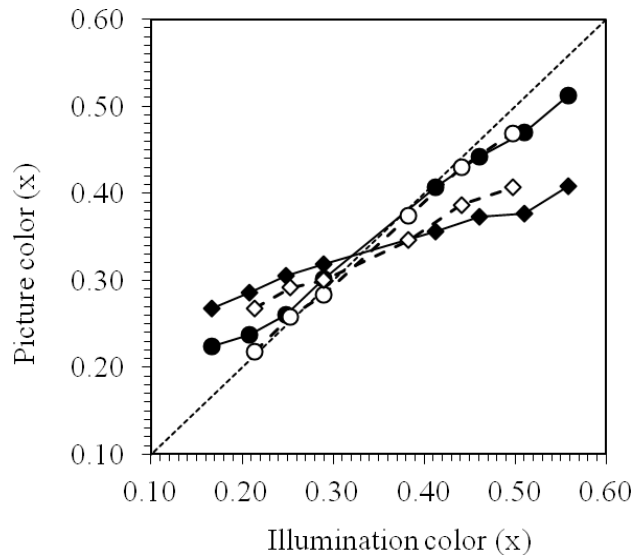

Fig. 6-1 Color of picture stimuli chosen for illumination color of the real room with the D-up viewer (filled symbols) and the stereoscope (open symbols).

In Fig. 6-1 we replotted the data given in Fig. 3-18 for the D-up technique and Fig. 4-12 for the stereoscopic technique. Filled symbols are from the D-up viewing condition and open symbols are from the stereoscopic viewing condition. Both techniques gave color constancy very close to the color constancy for real space as seen by the data points very close to 45° line. Particularly, blue side of the stereoscopic view and orange side up to $x = 0.441$ of both views the color constancy was same as for the real room. When the color of illumination became more vivid the data points gradually deviated from 45° line indicating less color constancy compared to the real room. We can think of some reasons for the deviation. One is imperfect reproduction of photographic images to the real space in terms of sharpness and color. For example there was a book opened and placed on the front shelf in the experimental room as seen in Fig.3-5 and subjects could see figures and text clearly. But in the D-up viewer the subjects could not read text nor see details of figures. This imperfection might have caused the less color constancy in the photographs. Another imperfection was the color reproduction. We could measure the color on the photographs at one point, a

white wall, and not colors of other objects in the experimental room because of less light available. Even for that one point the color reproduction was not perfect as we saw in Fig. 3-4 and Fig. 4-4, and it is conceivable that color reproduction was not good for other objects. This imperfect color reproduction might have caused the less color constancy compared to the real room. Another reason might be difference in the visual field situation between the real room and photographs. The horizontal visual angle for the front wall was different, 31° in the real room and 23° in the photograph in Experiment I and III. But more serious difference existed. On the left side of Fig. 6-2 a top view of the real room is schematically illustrated. The front wall was 100 cm

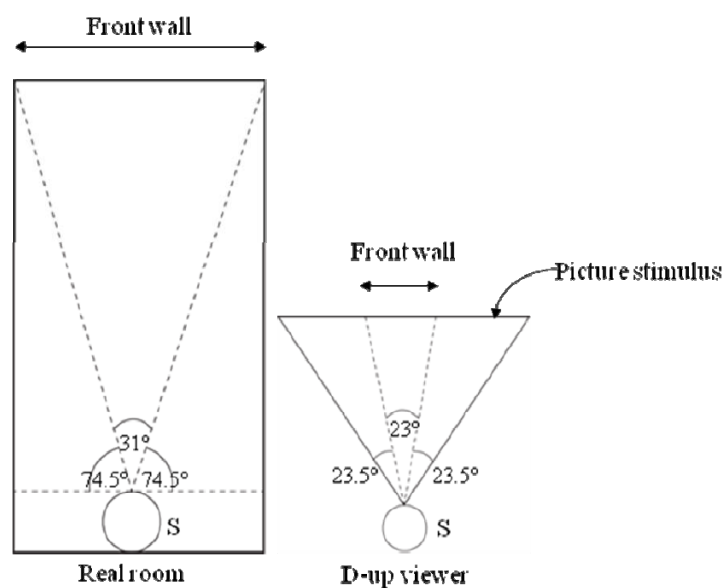

Fig. 6-2 Comparison of visual field of a subject in the case of real room (left) and D-up viewer (right).

wide and the distance to the subject S was 178 cm, thus making the visual angle of 31° as mentioned above. The subject could see the side walls to his/her left and right and the total visual angle for the room was at least 180° as he/she was asked to look around the room. The visual angle for one side of the wall was 74.5° . In the picture stimulus the width of the front wall was 11 cm or 23° with the viewing distance 27 cm as illustrated on the right side. The visual angle for one side of the wall was 23.5° , much smaller than 74.5° for the case of the real room. This difference of the visual angle for the real room and for the picture stimulus might have caused the less color constancy in the picture stimulus compared in the real room.

The color appearance experiment done in Experiment III is very similar to that done by Mizokami et al. [21] but there was found some difference between the two.

Variance among ten subjects that Mizokami et al. employed was large. Two subjects gave good color constancy but four subjects showed no color constancy at all. Three subjects showed some intermediate color constancy. In Experiment III there was variance among five subjects, but all of them responded with color appearance of vivid blue, particularly with the test stimulus N3, when the photograph was very orange as shown in Fig. 5-13b. Variance of color constancy among five subjects in Experiment I and II was very small and all of them showed the color constancy near to the color constancy for real room. It was already discussed about possible reasons for the difference between Mizokami et al.'s work and the present work but here another reason may be mentioned in the technique of assessing the color appearance. Mizokami et al. adopted the null method for the color appearance of a test patch, that is, subjects were asked to set the test patch to appear neutral or achromatic, while we adopted the elementary color naming method, which may be called the absolute judgment. This difference of method might have caused the difference between the two groups.

We obtained a little different results of the normal viewing between Experiment I and II as can be seen by diamonds in Fig. 6-1. If we take regression lines for these two sets of data their slopes are 0.332 in Experiment I and 0.495 in Experiment II. The result of Experiment II came closer to the 45° line indicating a closer result to the real room. In both cases a picture stimuli was placed in front of a subject and he/she just observed it. The observing situations looked same in both cases. Why the results were different? One difference of the experimental situation that we notice was the surrounding walls. In the case of Experiment I the surrounding wall was a white wall and there were some objects in the room, while in the case of Experiment II the room was entirely surrounded by black curtains. In other words there was not much visual information given to subjects other than the picture stimulus in Experiment I. We can suppose that the subject's brain tended to change the retinal image of the picture stimulus to a 3D space to some extent and some color constancy took place in the picture stimulus, thus giving a little bit whiter color impression for the picture stimuli.

6.2 Conclusion

Based on the recognized visual space of illumination RVSI theory a prediction was made that if one could perceive a three dimensional space in a photograph the color constancy should take place in the photograph. This prediction was confirmed by using a D-up viewer for the photograph and by employing a matching method of color impression for a real room and for a photograph. Delicate attention was paid in

constructing the D-up viewer so that no other information than the picture stimulus itself was given to a subject. The matching method proposed in this research provided the subject with easier and stable decision for the color impression. With these two methods the color constancy in photographs was found in every subject with small variance among subjects.

The color constancy in photographic images was confirmed in both techniques, the D-up viewer technique and a stereoscope technique. The two techniques gave similar results and good color constancy in photographs. One eye was used in the D-up technique and two eyes were used in the stereoscopic technique. The similar results indicated it was not important to use two eyes as long as subjects could perceive 3D scenes in photographs to get good color constancy.

The color appearance of stimulus patches of N3, N4, and N5 was investigated when they were inserted in photographs and the photographs were perceived as three dimensional scenes. The results showed that subjects adapted to the color of illumination used at the time of taking the photographs and perceived very vivid colors for the achromatic stimulus patch, indirectly confirming the color constancy in the photographs.

6.3 Suggestion for future research

It was always a problem in the present research that picture stimuli of a good quality sufficient to perceive 3D scenes exactly same as for a real space. To do similar experiments as the present research with photographs of which sharpness and color reproduction are improved will be a future research.

The difference of visual field situation was pointed out between a real space and a picture in the D-up viewer. It is desirable to provide the subjects with picture stimuli closer to the visual situation for a real room.

The D-up viewing technique can be used for studies about photographic images such as the lightness constancy, the shape constancy, and the size constancy.

REFERENCES

- [1] Ikeda, M., Motonaga, K., Matsuzawa, N. and Ishida, T. Threshold determination for unnatural color appearance with local illumination. Kogaku (Optics) 22 (1993):289. [In Japanese].
- [2] Ikeda, M., and Shima. F. Construction of the recognized visual space of illumination by increasing the Initial Visual Information. Journal of illumination engineering institute of Japan 79 (1995):392-399. [In Japanese].
- [3] Ikeda, M., and Kaneko, F. Effect of initial visual information on the recognized visual space of illumination –The case of lightness and saturation. Journal of illumination engineering institute of Japan 80 (1996):319-324. [In Japanese].
- [4] Ikeda, M., Shinoda, H. and Mizokami. Y. Three dimensionality of the recognized visual space of illumination proved by hidden illumination. Optical Review 5 (1998):200-205.
- [5] Ikeda, M., Kusumi, A. and Shinoda H. Color appearance seen through a colored filter of various sizes. Optical Review 8 (2001):480-486.
- [6] Ikeda, M., Yamauchi, R. and Shinoda, H. Effect of space recognition on the apparent lightness of gray patches demonstrated on printed patterns. Optical Review 10 (2003):382-390.
- [7] Ikeda, M. Color appearance explained, predicted and confirmed by the recognized visual space of illumination. Optical Review 11 (2004):217-225.
- [8] Pungrassamee, P., Ikeda, M., Katemake, P. and Hansuebsai, A. Color appearance determined by recognition of space. Optical Review 12 (2005):211-218.
- [9] Ikeda, M., Pungrassamee, P., Katemake, P. and Hansuebsai, A. The brain adaptation to the color of illumination and not the retinal adaptation to the color of objects that determines the color appearance of an object in the space. Optical Review 13 (2006):388-395.
- [10] Hedrich, M., Bloj, M. and Ruppertsberg, A. I. Color constancy improves for real 3D object. Journal of Vision 9 (2009):1-16.
- [11] De Almeida, V. M. N., Fiadiro, P. T. and Nascimento, S. M. C. Effect of scene dimensionality on colour constancy with real three-dimensional scenes and objects. Perception 39 (2010):770-779.
- [12] Kraft, J. M., Maloney, S. I. and Brainard, D. H. Surface-illuminant ambiguity and

- color constancy: Effects of scene complexity and depth cues. Perception 31 (2002):247-263.
- [13] Ikeda, M., Shinoda, H. and Mizokami, Y. Phenomena of Apparent Lightness Interpreted by the Recognized Visual Space of Illumination, RVSI. Optical Review 5 (1998):380-386.
- [14] White, M. A new effect of pattern on perceived lightness. Perception 8 (1979):413-416.
- [15] Heinemann, E. G. Simultaneous brightness induction as a function of inducing and test-field luminances. Journal of experimental psychology 50 (1955):89-96.
- [16] Gilchrist, A. Perceived lightness depends on perceived spatial arrangement. Science 195 (1977):185-187.
- [17] Brainard, D. H., Brunt, W. A. and Speigle, J. M. J. Color constancy in the nearly natural image. I. Asymmetric matches. Journal Optical Society of America A14 (1997):2091-2110.
- [18] Brainard, D. H., Color constancy in the nearly natural image. 2. Achromatic loci. Journal Optical Society of America A15 (1998):307-325.
- [19] Kraft, J. M. and Brainard D. H. Mechanisms of color constancy under nearly natural viewing. Proceeding of the National Academy of Sciences of the United States of America 96 (1999):307-312.
- [20] Xiao, B., Hurst, B., MacIntyre, L. and Brainard, D. H. The color constancy of three-dimensional objects. Journal of Vision 12 (2012): 1-15.
- [21] Mizokami, Y., Ikeda, M. and Shinoda, H. Color constancy in a photograph perceived as a three-dimensional space. Optical Review 11 (2004):288-296.
- [22] De Almeida, V. M. N., Fiadeiro, P. T. and Nascimento, S. M. T. Color constancy by asymmetric color matching with real objects in the three-dimensional scenes. Visual Neuroscience 21 (2004): 341-345.
- [23] Arend, L. E. and Reeves, A. Simultaneous color constancy. Journal Optical Society of America A3 (1986): 1743-1751.
- [24] Ikeda, M., Mizokami, Y., Nakane, S. and Shinoda, H. Color appearance of a patch explained by RVSI for the conditions of various colors of room illumination and of various luminance levels of the patch. Optical Review 9 (2002):132-139.
- [25] Ikeda, M., Hattori, Y. and Shinoda, H. Color modification of pictures requiring same color impression as real scene. Optical Review 9 (2002):282-292.
- [26] Thouless, R. H. Phenomenal regression to the real object. I. British Journal

- Psychology 21 (1931):339-359.
- [27] Woodworth, R. S. and Schlosberg, H. Visual depth perception. Experimental Psychology. Henry Holt and Co., 1956.
- [28] Leibowitz, H. W. Visual Perception. Macmillan Co., 1965.
- [29] Graham, C. H. Visual space perception. Vision and Visual Perception, C. H. Graham, ed. Wiley, 1966.
- [30] Kuriki, I. and Uchikawa, K. Limitations of surface-color and apparent-color constancy. Journal Optical Society of America A 13 (1996):1622-1636.
- [31] Thiangthangtum, Y., Ikeda, M. and Shinoda, H. Room illuminance rather than immediate surrounding luminance determines natural color of an object border. Optical Review 11 (2004):235-239.

APPENDIX

APPENDIX

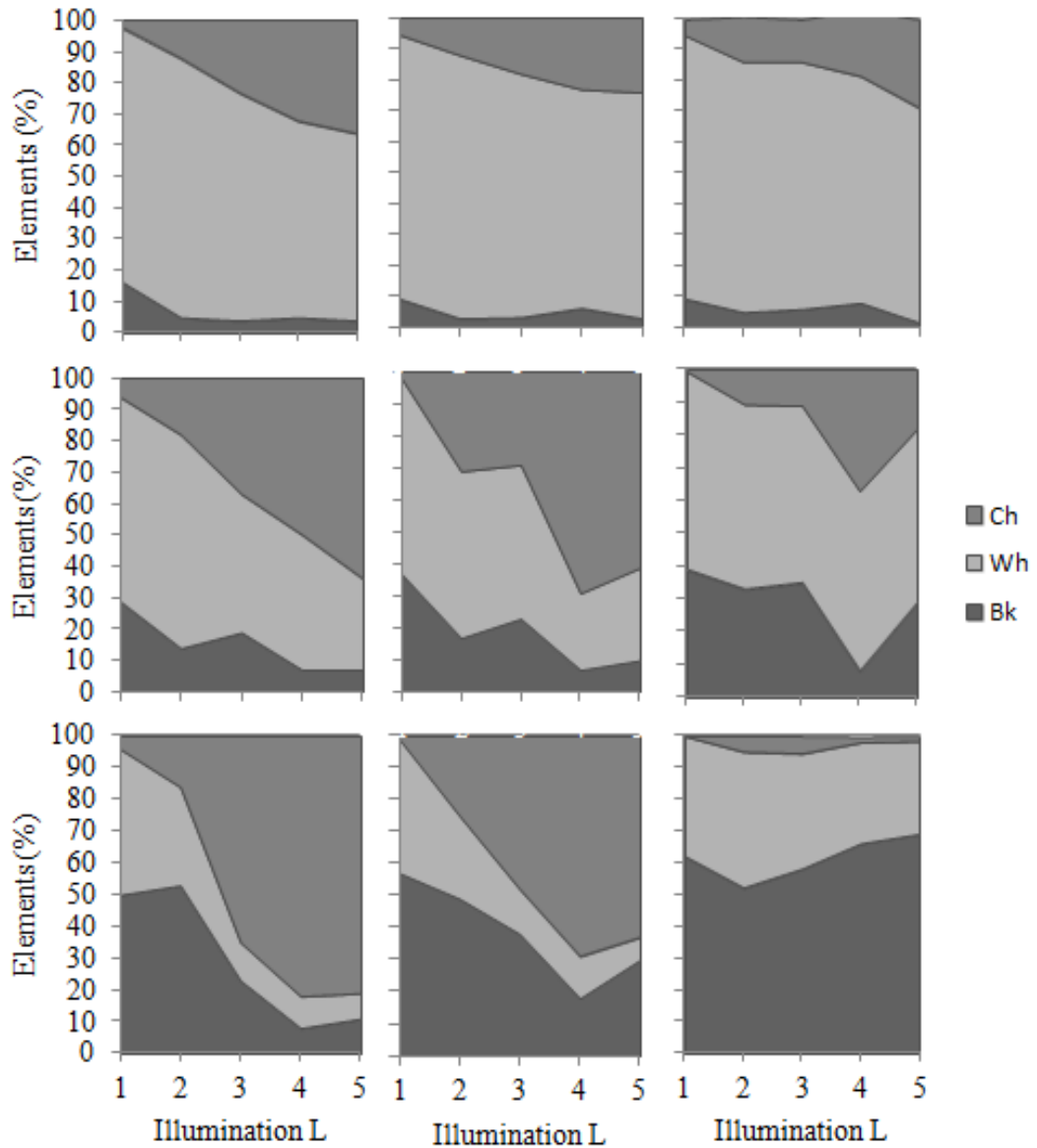

Appendix A Amounts of elements in percentage plotted for illumination L, chromaticness (gray), whiteness (white), blackness (black). Subject, MI.

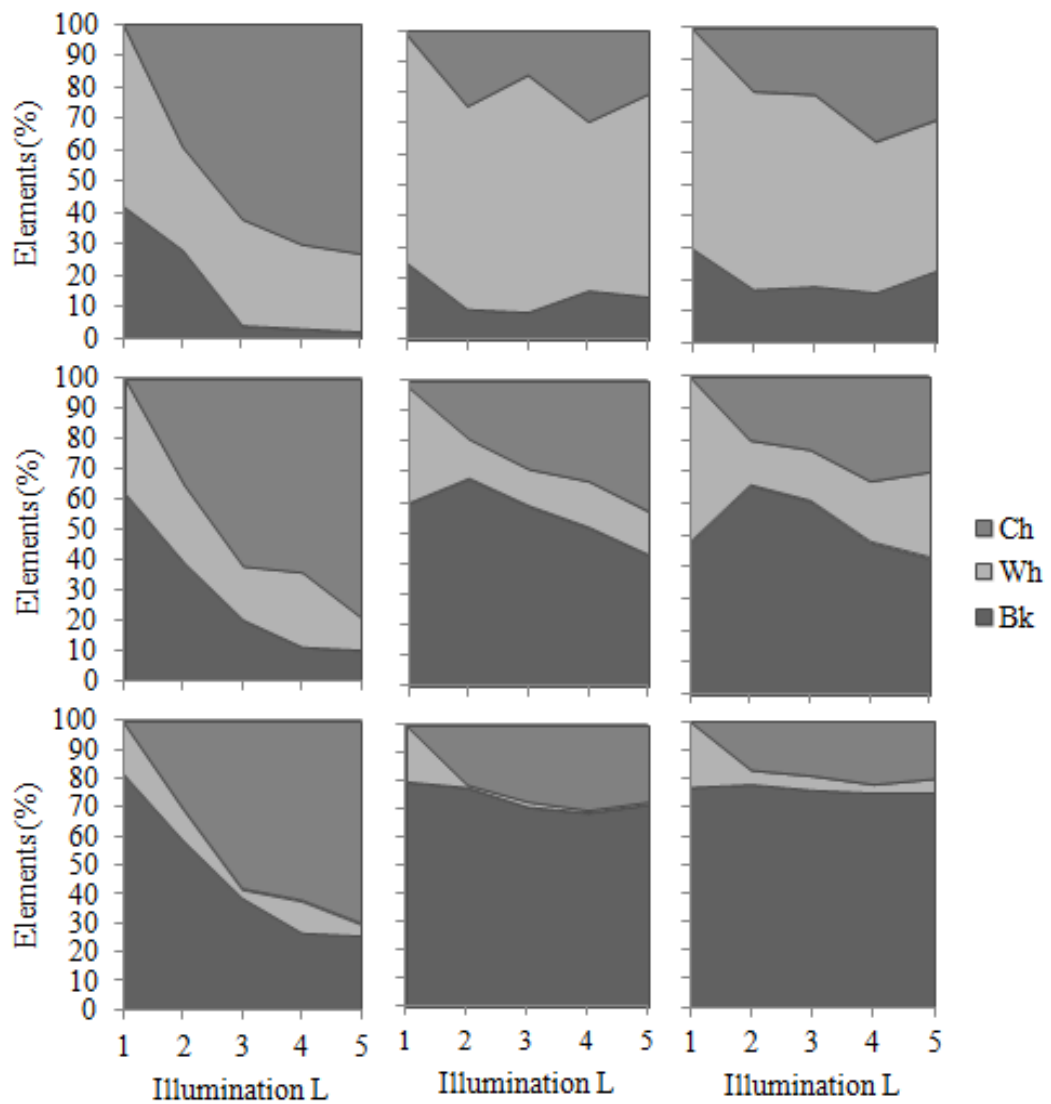

Appendix B Amounts of elements in percentage plotted for illumination L, chromaticness (gray), whiteness (white), blackness (black). Subject, PC.

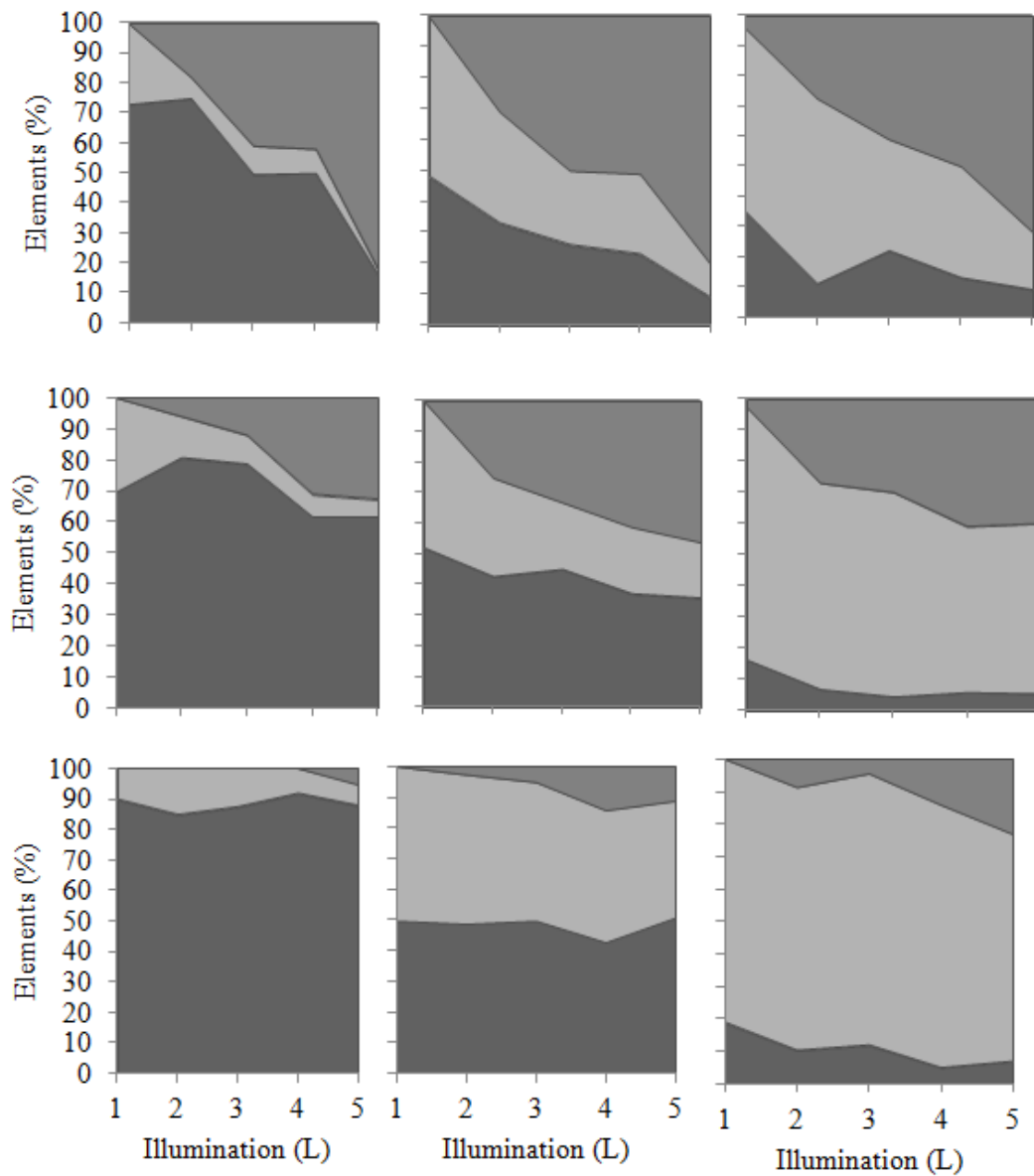

Appendix C Amounts of elements in percentage plotted for illumination L, chromaticness (gray), whiteness (white), blackness (black). Subject, CP.

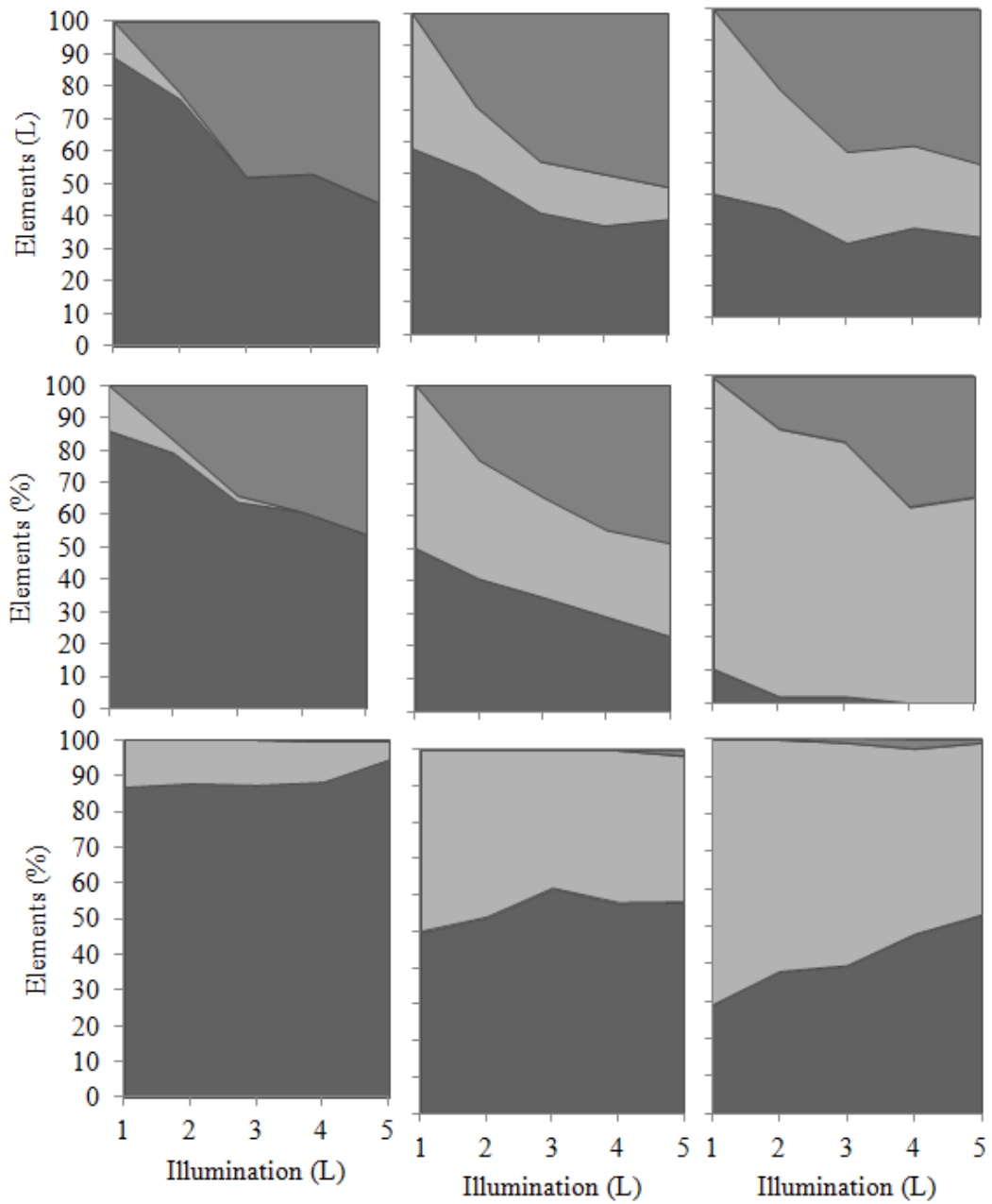

Appendix D Amounts of elements in percentage plotted for illumination L, chromaticness (gray), whiteness (white), blackness (black). Subject, SS.

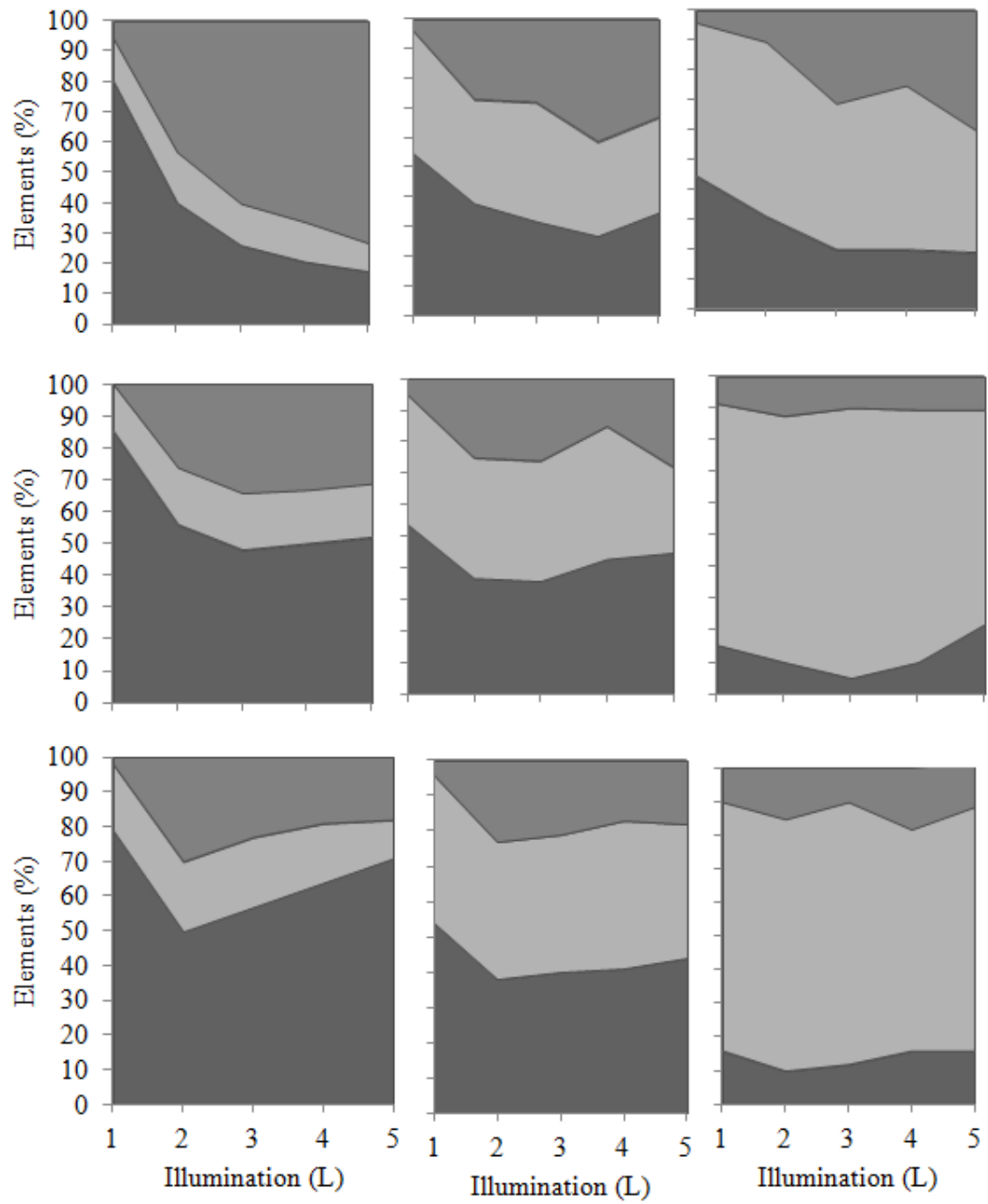

Appendix E Amounts of elements in percentage plotted for illumination L, chromaticness (gray), whiteness (white), blackness (black). Subject, RW.

BIOGRAPHY

Miss Chanprapha Phuangsuwan

Date of birth: 24th June 1978 at Lopburi, Thailand

Education:

2001: Bachelor's Degree of Science in Printing Technology

At Department of Printing Technology, Faculty of Agricultural Technology, Rajamanjala University of Technology Thanyaburi.

2005: Master's Degree of Science in Printing Education Technology

At Department of Education Technology, Faculty of Education, King Mongkut's University of Technology Thonburi

Work experience:

2001-Present: Lecturer at Department of Printing Technology, Faculty of Mass Communication Technology.

Academic publications

Phuangsuwan, C., Ikeda, M., Katemake, P. and Obama, T. Color constancy observable in a picture. Journal of the Color Science Association of Japan 34 (2010):36-37.

Phuangsuwan, C., Ikeda, M., Katemake, P. Space recognition and the color constancy. Journal of the Color Science Association of Japan 35 (2011):100-101.

Phuangsuwan, C., Shinoda, H., Rattanasamsuk, K., Ikeda, M. and Katemake, P. The color constancy in a 3D space perceived stereoscopically, Journal of the Color Science Association of Japan 36(2012):222-223.