

## CHAPTER II



## THEORY

For the understanding of this thesis, the definitions and theories of the following terms will be described: carbon nanotube (CNT), polyol process, related electrodes, electrochemical techniques, and characterization techniques.

### 2.1 Carbon Nanotube (CNT) [36]

CNT is one allotrope of carbon, configurationally equivalent to hexagonal network of carbon atoms that has been rolled up to make a seamless cylinder. Its cylindrical carbon molecules have novel properties that make CNTs be potentially useful in many applications in nanotechnology, electronics, optics, and other fields of material science. CNTs have attracted enormous interest since their unique structural, mechanical, and electronic properties. These properties include high chemical and thermal stability, high elasticity, and high tensile strength. Some tubes may exhibit metallic conductivity. However, the toxicity of CNTs may possibly limit their usages. Conceptually, CNTs can be thought of as  $sp^2$  carbons arranged in graphene sheets which are rolled up to form a seamless hollow tube. They can be subdivided into two classes: single-walled carbon nanotube (SWCNT) and multi-walled carbon nanotube (MWCNT).

#### 2.1.1 Single-Walled Carbon Nanotube (SWCNT)

SWCNT consists of a single hollow tube with diameters between 0.4 and 2 nm. SWCNTs exhibit some unique electrochemical properties, but they are extremely expensive to be produced.

#### 2.1.2 Multi-Walled Carbon Nanotube (MWCNT)

MWCNT is composed of multiple concentric nanotubes with 0.34 nm apart between layers, making the final MWCNT has diameters of 2-100 nm.

MWCNTs are regarded as metallic conductors that have highly attractive properties as electrode materials. Note that MWCNTs do not share some characteristics features of SWCNTs, but they are cheaper.

## 2.2 Polyol Process [37,38]

Polyol process is a synthetic technique for the preparation of well-dispersed metal powders. This process involves a redox reaction between the metallic compound and liquid polyol.

Since 1980s, polyol process has been largely used to prepare nanoparticles of various metals such as platinum, nickel, bismuth, cobalt, silver, gold, and palladium. Polyol process offers simplicity, convenience, less energy-demanding, and less material-consuming. Synthesis of metal nanoparticles using this process requires dissolution of the metal precursor in a liquid polyol, *e.g.*, ethylene glycol, diethylene glycol, triethylene glycol, or tetraethylene glycol, functioning as both solvent and a reducing agent. In addition, the liquid polyol often acts as a protecting agent that prevents interparticle sintering. The reaction rate is controlled by adjusting the temperature to acquire the reduction including the condensation of metal ions from solution and finally the formation of metal nanoparticles. Rigorous adjustment of different parameters such as temperature, precursor type, precursor amount, and the order of reactant addition allows control of size, shape, and size distribution of the particles. Each metal synthesis is therefore a special case that requires optimization of reaction conditions.

## 2.3 Electrodes for Electrochemical Measurement [39-41]

For electrochemical measurement, the three electrode system consisting of working, auxiliary, and reference electrodes is commonly used. Working electrode is the electrode at which the reaction of interest occurs whereas the reference electrode provides a stable, constant, and well-known potential, allowing the potential of working electrode to be determined. An inert conducting material such as platinum or carbon can be used as the current-carrying auxiliary electrode. The performance of the electrochemical measurement is strongly influenced by the material of the

working electrode. Popular materials for working electrodes are mercury, carbon, and noble metals. This work focuses on using glassy carbon as a main working electrode.

### 2.3.1 Glassy Carbon (GC) Electrode

GC, also referred to as vitreous carbon, has been popular working electrode because of its excellent mechanical and electrical properties, wide potential window, chemical inert feature, and relatively reproducible performance. The chemical structure of this electrode involves thin and tangled ribbons of cross-linked graphite-like sheets. Due to its high density and small pore size, no impregnating procedure is required. However, the pretreatment for the GC surface is usually employed to create active and reproducible electrode as well as to enhance the electrode performance. Such pretreatment step is achieved by polishing GC electrode with alumina particles on polishing cloth and then rinsing the electrode with deionized water before use.

### 2.3.2 Bismuth electrode

Bismuth electrode, one of the most widely used electrodes for stripping analysis, consists of a very thin bismuth film or precursor of metallic bismuth covering a suitable supporting material. Bismuth film can form fused alloys with other metals as mercury film can form amalgams with metals. Moreover, the attractive properties of bismuth electrodes include simple preparation, high sensitivity, insensitivity to dissolved oxygen, large anodic potential range, and low toxicity. Bismuth electrodes can be classified into three main types: *in situ* bismuth film electrode, *ex situ* bismuth film electrode, and bismuth modified electrode.

#### 2.3.2.1 *In Situ* Bismuth Film Electrode

*In situ* bismuth film electrode is often employed for stripping analysis. The electrode is prepared by simultaneous deposition of bismuth (III) ions and the measured metal ions as alloys on a conducting substrate. According to equations 2.1 and 2.2, the alloy of bismuth and metal can be achieved:



when  $M^{2+}$  and  $M(\text{Bi})$  represent metal ion and alloy of bismuth and metal, respectively. Therefore, in order to prepare *in situ* bismuth film electrode, the solution of bismuth (III) ions must be present in the sample solution containing metal ions of interest (analyte).

### 2.3.2.2 *Ex Situ* Bismuth Film Electrode

*Ex situ* bismuth film electrode is made by reducing bismuth (III) ions to metallic bismuth on a suitable supporting material, as equation 2.1. Subsequently, this *ex situ* bismuth film electrode is immersed in the sample solution which contains only the metal ions of interest.

### 2.3.2.3 Bismuth Modified Electrode

Bismuth modified electrode is prepared by mixing bismuth powder or bismuth precursor compound such as bismuth (III) oxide ( $\text{Bi}_2\text{O}_3$ ) with binder and then modifying the mixture onto the selected electrode. In comparison with *in situ* or *ex situ* bismuth film electrodes, the bismuth modified electrode can be simply fabricated since it does not require the addition of bismuth (III) ion solution or additional plating step before the analysis.

## 2.4 Electrochemical Techniques [39]

Electrochemical techniques are formally classified by International Union for Pure and Applied Chemistry (IUPAC) on the basis of their working principles. Although many electrochemical methods are available, only cyclic voltammetry, stripping analysis, and chronoamperometry are discussed in this thesis.

### 2.4.1 Cyclic Voltammetry

Cyclic voltammetry is widely used electrochemical technique that acquires qualitative information about the properties and characteristics of the electrochemical process. The significance of cyclic voltammetry results from its efficiency to rapidly provide considerable information about the thermodynamics of redox processes, the kinetics of heterogeneous electron-transfer reactions, and the

nature of coupled chemical reactions or adsorption processes. Thus, cyclic voltammetry is often the first experiment performed in an electroanalytical investigation. In particular, it offers rapid locations of redox potentials for electroactive species and convenient evaluation of medium effect upon the redox processes.

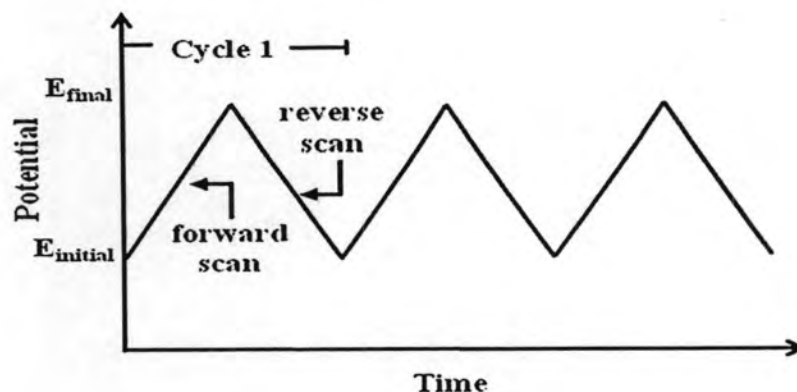

**Figure 2.1** Potential-time profile used in cyclic voltammetry.

Cyclic voltammetry includes a linear potential scan of a stationary working electrode immersed in an unstirred solution using a triangular potential waveform showed in Fig. 2.1. Depending on the information sought, single or multiple cycles can be performed. During the potential sweep, the potentiostat measures the current resulting from the applied potential. The plot of current *versus* voltage scan is termed as a cyclic voltammogram which represents characteristic features of a redox process depending on a large number of physical and chemical parameters.



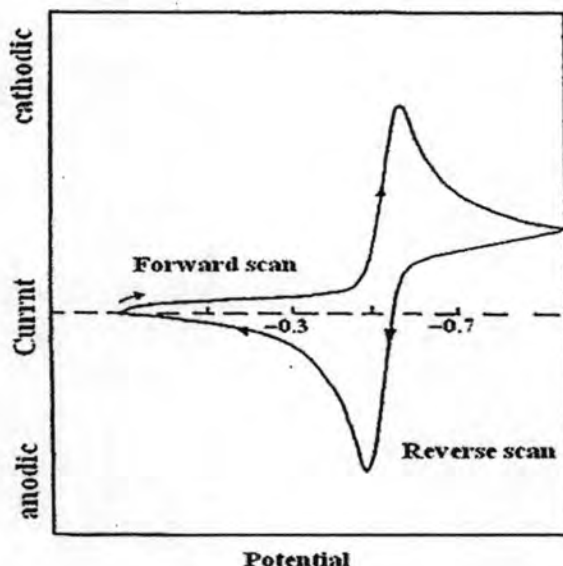

**Figure 2.2** Typical cyclic voltammogram for a reversible redox process.

Fig. 2.2 illustrates the expected response of a reversible redox couple during a single potential cycle. It is assumed that only the oxidized form, O, is present initially. Thus, a negative-going potential scan is chosen for the first half-cycle, starting from a potential value where no reduction occurs. As the voltage scan approaches the characteristic  $E^0$  for the redox process, a cathodic peak current begins to increase until the peak is reached. After traversing the potential region in which the reduction takes place, the direction of the voltage scan is reversed. During the reverse scan, the reduced form, R, (generated in the forward half-cycle and accumulated near the electrode surface) re-oxidizes back to O, resulting in an anodic peak current.

#### 2.4.2 Stripping Analysis

Stripping analysis is an excellently sensitive electrochemical technique for measuring trace metals. It consists of two steps: deposition step and stripping step. The first step involves the electrolytic deposition or accumulation of a small portion of the metal ions in solution to the working electrode in order to preconcentrate the metals. Next step is the stripping or measurement step which involves the dissolution or stripping of the deposited metals. Different versions of stripping analysis can be used, depending upon the nature of the deposition and stripping steps. In this thesis, anodic stripping voltammetry (ASV) was employed for the analysis of cadmium (II) and lead (II) ions.

### 2.4.2.1 Anodic Stripping Voltammetry (ASV)

ASV is one type of stripping analysis where the metal ions are preconcentrated by electrodeposition on the working electrode via reduction process. During this step, the solution is continuously stirred to produce the forced convection, allowing more metal deposition. Following the deposition step, the stirring is stopped and the voltammogram is recorded by applying a positive-going potential scan. Thus, stripping voltammogram will display anodic peaks for the oxidation of deposited metals.

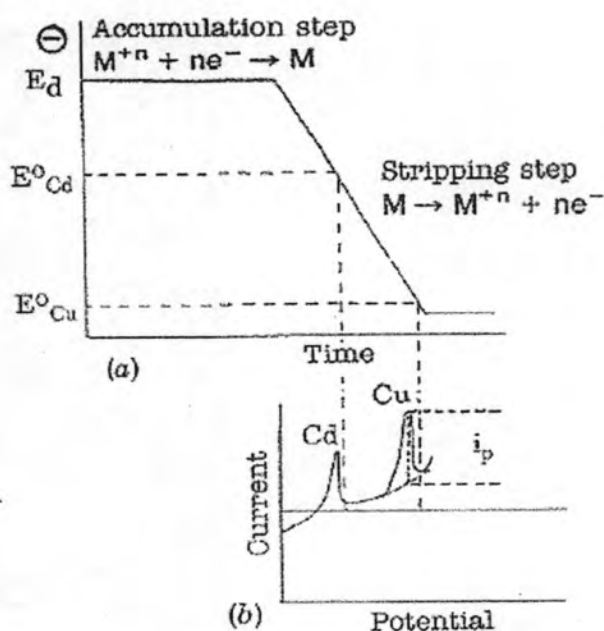
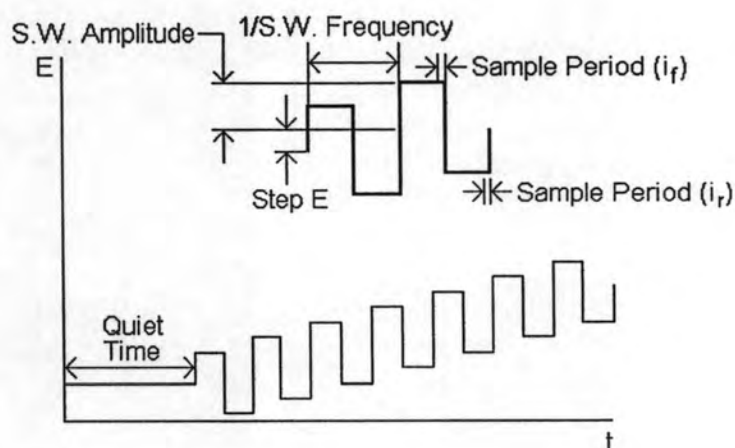

**Figure 2.3** (a) Potential-time waveform and (b) stripping voltammogram of anodic stripping voltammetry.

Fig. 2.3 shows potential-time wave form of ASV and a plot of current versus applied potential or a stripping voltammogram. The voltammetric peaks reflect the time-dependent concentration gradient of metals deposited at the working electrode.

### 2.4.2.2 Square Wave Anodic Stripping Voltammetry (SWASV)

SWASV uses square wave voltammetry (SWV) at the stripping step of ASV. Discriminating against the charging current, SWV is based on the difference in current decaying rates following a potential step. Shown in Fig. 2.4, the square wave potential-time waveform involves the superposition of small square-wave potential amplitude on the staircase ramp. By sampling the current just before the square wave changes polarity, the corrected value of the changing current is obtained. Moreover, the analytical current is enhanced by combining the opposite current associated with the metal replating.

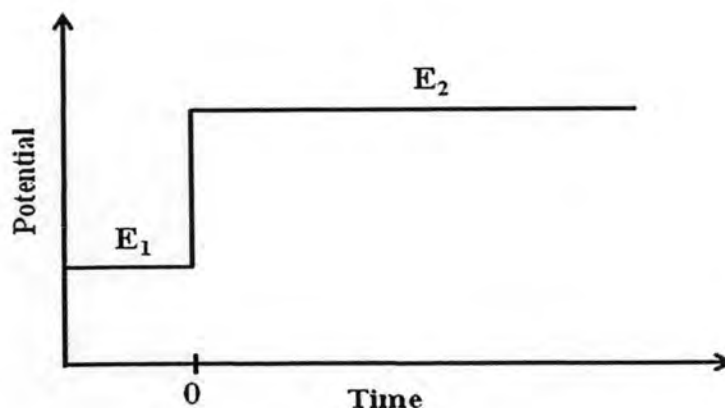

**Figure 2.4** Potential-time waveform used in square wave voltammetry.

### 2.4.3 Chronoamperometry

Chronoamperometry involves stepping the potential of the working electrode from a value at which no faradaic reaction of an electroactive substance occurs to a potential at which the faradaic reaction occurs until the concentration of the electroactive substance at the electrode surface is effectively zero. Fig. 2.5 displays the applied potential-time waveform of this technique.





**Figure 2.5** Potential-time waveform of chronoamperometry.

Chronoamperometry is often performed for the measurement of the diffusion coefficient of electroactive substance or the surface area of working electrode. Analytical application of this method relies on pulsing of the working electrode potential repetitively at fixed time intervals. Additionally, this technique can also be applied to study the mechanisms of electrode processes.

## 2.5 Characterization Techniques

### 2.5.1 Infrared (IR) Spectroscopy [42]

IR spectroscopy studies the interaction of IR electromagnetic radiation with matter and uses this interaction to identify chemical structure. Electromagnetic radiation is composed of electric and magnetic waves that are in planes perpendicular to each other and the radiation travels through space in a plane perpendicular to the planes of electric and magnetic waves. It is the electric part of the radiation called the electric vector that interacts with matter. When there is an interaction between the IR radiation and a molecule, the radiation can be absorbed by the molecule causing the chemical bonds in the molecule to vibrate. Chemical structural fragment within a molecule, known as a functional group, tends to absorb IR radiation in the same wavenumber range regardless of the structure of the rest of the molecule in which the functional group stays. This correlation between a functional group and the wavenumber of its absorbed IR allows the structure of an unknown molecule to be identified from the molecule's IR spectrum, making IR spectroscopy a useful chemical analysis tool.

### 2.5.2 X-ray Diffraction (XRD) Technique [43]

XRD is a suitable technique used for identification and characterization of unknown crystalline materials. Initially, an atom of the solid sample is hit by X-ray beam, the electrons around this atom start to oscillate with the same frequency as the incoming X-ray beam. Then, the diffraction beam occurs when the X-ray beam encounters the sample. The diffraction beam can be described as the apparent bending of waves around small samples and the spreading out of waves past small openings. In almost all directions, destructive interferences will occur since the combining waves are out of phase and there is no resultant energy leaving the solid sample. However, the atoms in a crystal are arranged in a uniform pattern generating constructive interferences in a few directions. The combining waves will be in phase causing well defined X-ray beams. Therefore, a diffraction beam may be described as a beam composed of a large number of scattered rays mutually reinforcing one another.

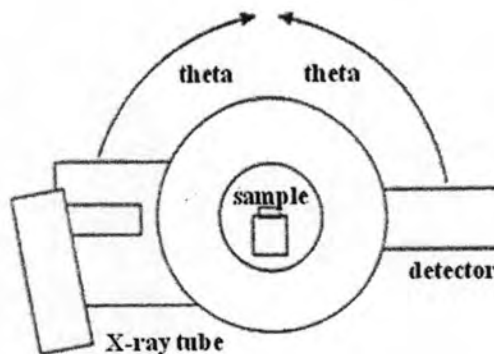

**Figure 2.6** One possible configuration of the XRD instrument.

Fig. 2.6 presents the simplified sketch of one possible configuration of XRD instrument, which shows X-ray tube and X-ray detector both move through the angle  $\theta$  while the sample remains stationary. A detector detects an X-ray signal, which is then processed and converted into a count rate either electronically or by a microprocessor.

### 2.5.3 Transmission Electron Microscopy (TEM) [44]

TEM is commonly employed to study the internal microstructure and crystal structure of samples that are thin enough to transmit electrons with relatively little loss of energy. This fact requires sample thicknesses in the range 20-300 nm, depending on the average atomic number of the material, when the typical 200 keV TEM is used. Thus, TEM has greater resolving capability as well as wider and higher magnification ranges than the light microscope does. The quality of the image in TEM depends on not only the expertise of the microscopist, but also the quality of the sample preparation.

For TEM, the principle is to produce sample image by electron source at the top of the microscope. The electron source is followed by two condenser lenses to provide a uniform illumination of the specimen over the area of interest that is adjustable as the magnification is changed. The sample is mounted on the stage to provide suitable movement. The primary image is formed by the objective lens which determines the obtainable resolution. The final image is produced on a viewing screen through two or more projection lenses. Its image can be recorded on film placed below the screen or using CCD array detectors.

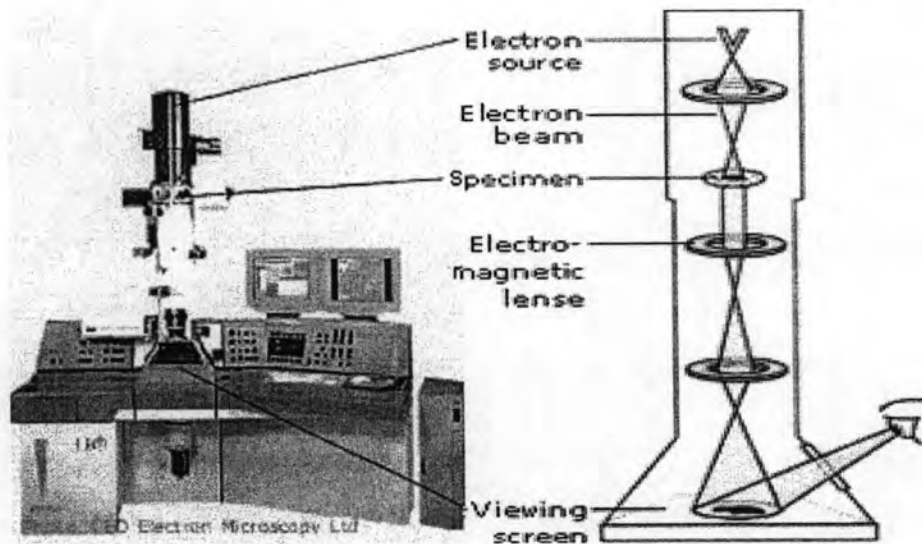

**Figure 2.7** Schematic representation of a TEM.

### 2.5.4 Energy Dispersive X-ray Fluorescence (EDXRF) Spectroscopy [43]

EDXRF analysis can be considered as a relatively new analytical technique. It separates characteristic X-ray on the basis of its photon energies rather than its wavelengths. It is not only a powerful and versatile analysis method by its own, but sometimes used as an accessory to other instruments because of its compactness. EDXRF analysis is powerful tool for elemental analysis and chemical analysis, particularly in the investigation of metals, glass, ceramics, and building materials as well as research in geochemistry, forensic science, and archaeology.

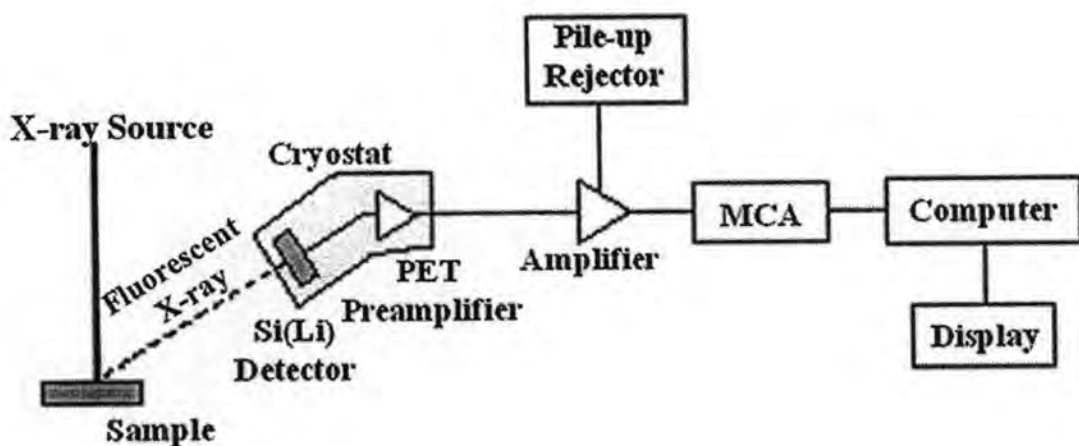

**Figure 2.8** Schematic representation of an EDXRF spectrometer.

Fig. 2.8 exhibits schematic representation of an EDXRF spectrometer. The elements in sample are excited by X-ray beam. Characteristic fluorescent X-ray from a specimen irradiated with a primary X-ray beam enters a cooled lithium-drifted silicon (Si(Li)) detector which is connected to an amplifier system. It is necessary to cool the detector to liquid nitrogen temperatures in order to reduce electronic noise and to ensure best resolution. Once the fluorescent X-rays of the sample hit the Si(Li) detector, the detector produces a continuous distribution of pulses with their voltages being proportional to the incoming photon energies. Then, the pulse signal is processed by a multichannel analyzer (MCA), which generates an accumulating digital spectrum that can be further processed to obtain analytical data. To be more precise, the detector converts the fluorescent X-ray into electron-hole pairs, which are then swept out of the detector by an applied voltage. In addition, the intensity of each characteristic radiation is directly related to the amount of each

element in the material. The main limitations of the technique are imposed by (i) the Si(Li) detector which cannot detect elements lighter than sodium and (ii) the resolution of low energy radiation (long wavelength) is poorer than that of wavelength dispersive X-ray fluorescence spectroscopy.